

1 Terminal Blocks

*The following information covers PBA300F - 1500F. Please see External View for PBA10F - 150F and PBW15F - 50F.

● PBA300F

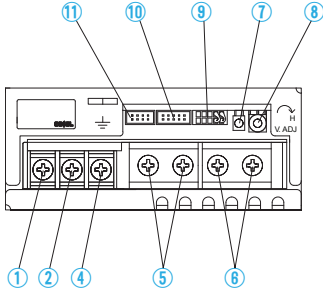

● PBA600F

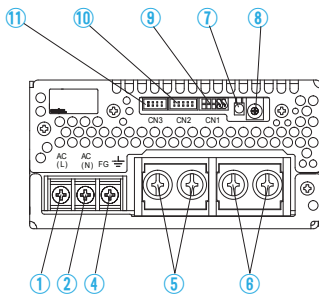

● PBA1000F

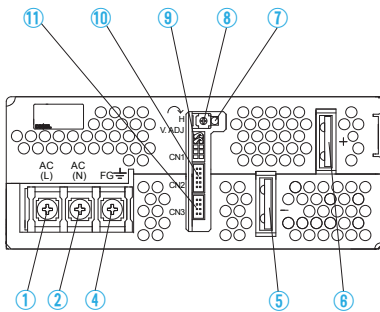

● PBA1500F

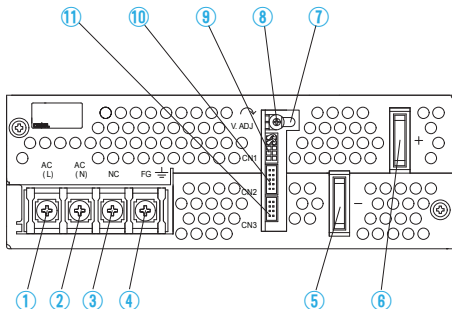

- ① AC (L) } Input Terminals AC85 - 264V ϕ 47 - 63Hz
- ② AC (N) } (M4)
- ③ NC
- ④ Frame ground (M4 \perp)
- ⑤ -Output
- ⑥ +Output
- ⑦ LED
- ⑧ Output voltage adjustable potentiometer
- ⑨ CN1
- ⑩ CN2 } Connectors
- ⑪ CN3 }

*Please see Optional Parts for dedicated harnesses.

● PBA1500T

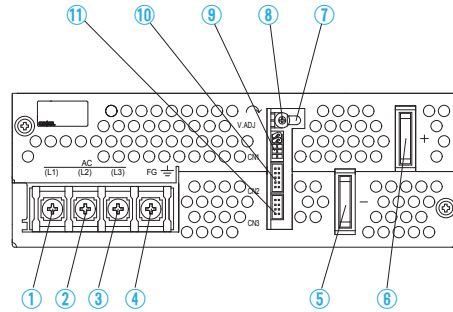

- ① AC (L1)
- ② AC (L2)
- ③ AC (L3)
- ④ Frame ground (M4 \perp)
- ⑤ -Output
- ⑥ +Output
- ⑦ LED
- ⑧ Output voltage adjustable potentiometer
- ⑨ CN1
- ⑩ CN2 } Connectors
- ⑪ CN3 }

Pin Configuration and Functions of CN1

Pin No.	Function
1	+M : Self sensing terminal. (Do not wire for external connection.)
2	+S : +Sensing
3	-M : Self sensing terminal. (Do not wire for external connection.)
4	-S : -Sensing
5	VB : Voltage balance
6	CB : Current balance
7	TRM : Adjustment of output voltage
8	-S : -Sensing
9	RC2 : Remote ON/OFF
10	RCG : Remote ON/OFF (GND)

Pin Configuration and Functions of CN2

Pin No.	Function
1	+M : Self sensing terminal. (Do not wire for external connection.)
2	+S : +Sensing
3	-M : Self sensing terminal. (Do not wire for external connection.)
4	-S : -Sensing
5	VB : Voltage balance
6	CB : Current balance
7	TRM : Adjustment of output voltage
8	-S : -Sensing
9	RC2 : Remote ON/OFF
10	RCG : Remote ON/OFF (GND)

Pin Configuration and Functions of CN3

Pin No.	Function
1	-S : -Sensing
2	-S : -Sensing
3	AUX : Auxiliary output (12V 0.1A)
4	RC1 : Remote ON/OFF
5	AUXG : Auxiliary output (GND)
6	N.C. : No connection
7	PG : Alarm
8	PGG : Alarm (GND)

*Common signs among CN1, CN2 and CN3 such as -S represent the same potential.

Matching connectors and terminals on CN1, CN2 and CN3

Connector	Housing	Terminal	Mfr.
CN1 CN2	S10B-PHDSS	Reel : SPHD-002T-P0.5 Loose : BPHD-001T-P0.5	J.S.T.
CN3	S8B-PHDSS		

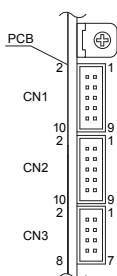
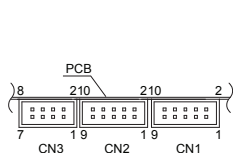

●PBA300F/600F

●PBA1000F/1500F/1500T

Connector pin numbers

2 Functions

2.1 Input Voltage Range

- **PBA10F, PBA15F, PBW15F, PBA30F, PBW30F, PBA50F, PBW50F, PBA75F, PBA100F, PBA150F, PBA300F, PBA600F, PBA1000F and PBA1500F**

- Input voltage range of the power supplies is from AC85V to AC264V or DC (please see SPECIFICATIONS for details).
- In cases that conform with safety standard, input voltage range is AC100-AC240V (50/60Hz).
- If input value doesn't fall within above range, a unit may not operate in accordance with specifications and/or start hunting or fail. If you need to apply a square waveform input voltage, which is commonly used in UPS and inverters, please contact us.
- When the input voltage changes suddenly, the output voltage accuracy might exceed the specification. Please contact us.

- **PBA1500T**

- The input voltage range is AC170-264V (three-phase).
- In cases that conform with safety standard, input voltage range is AC200-AC240V (50/60Hz).
- The input phase line shall not be specified, it can be connected to any input terminal.
- In the case of three-phase four-wire system, connect the three wires to input terminal (L1, L2, L3), except ground wire.

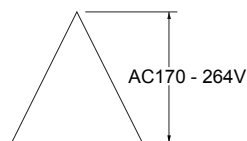

Delta connection

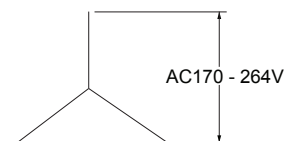

Star connection

- If the wrong input or single phase input is applied, the unit will not operate properly and/or may be damaged. If you need to apply a square waveform input voltage, which is commonly used in UPS and inverters, please contact us.

- **PBA10F, PBA15F, PBW15F, PBA30F and PBW30F**

- A power factor improvement circuit (active filter) is not built-in. If you use multiple units for a single system, standards for input harmonic current may not be satisfied. Please contact us for details.

- **PBA10F, PBA15F, PBW15F, PBA30F, PBW30F, PBA50F, PBW50F, PBA75F, PBA100F and PBA150F**

- Operation stop voltage is set at a lower value than that of a standard version (derating is needed).

· Use Conditions

	Output ()	3.3V, ±5V
PBA10F	5W	PBA50F 15W (10W)
PBA15F	7.5W (5W)	PBW50F 15W (10W)
PBW15F	7.5W	PBA75F 35W (20W)
PBA30F	10W (7.5W)	PBA100F 50W (30W)
PBW30F	10W (7.5W)	PBA150F 65W (40W)

Input AC50V (DC70V)

Duty 1s/30s

* Please avoid using continuously for more than 1 second under above conditions. Doing so may cause a failure.

* PBA10F, PBA15F, PBA30F and PBW30F become only AC200V. If you use the unit at AC100V, please contact us.

- **PBA300F, PBA600F, PBA1000F, PBA1500F and PBA1500T**

- You can use a unit with an input voltage lower than AC85V and DC120V (PBA1500T is AC170V 3φ) by option (please see 7. Options). If you do so, load derating is necessary. Please contact us for details.

2.2 Inrush Current Limiting

- An inrush current limiting circuit is built-in.
- If you need to use a switch on the input side, please select one that can withstand an input inrush current.

- **PBA10F**

- Resistance for load factor is used for inrush current limiting.

- **PBA15F, PBW15F, PBA30F, PBW30F, PBA50F, PBW50F, PBA75F, PBA100F and PBA150F**

- Thermistor is used in the inrush current limiting circuit. When you turn the power ON/OFF repeatedly within a short period of time, please have enough intervals so that a power supply cools down

● **PBA300F, PBA600F, PBA1000F, PBA1500F and PBA1500T**

- Thyristor technique is used in the inrush current limiting circuit. When you turn the power ON/OFF repeatedly within a short period of time, please have enough intervals so that the inrush current limiting circuit becomes operative.
- When the switch of the input is turned on, the primary inrush current and secondary inrush current will be generated because the thyristor technique is used for the inrush current limiting circuit.

2.3 Overcurrent Protection

- An overcurrent protection circuit is built-in and activated at 105% of the rated current or 101% of the peak current. A unit automatically recovers when a fault condition is removed. Please do not use a unit in short circuit and/or under an overcurrent condition.
- Intermittent Operation Mode
When the overcurrent protection circuit is activated and the output voltage drops to a certain extent, the output becomes intermittent so that the average current will also decrease.

● **PBA1000F, PBA1500F and PBA1500T**

- Output Voltage Shutdown
If the overcurrent protection circuit operates continuously for 5 seconds, the output voltage will shut down. To recover the output voltage, remove a condition that is causing an overcurrent, shut down the input voltage, wait more than 3 minutes and turn on the AC input again.

2.4 Overvoltage Protection

- An overvoltage protection circuit is built-in. If the overvoltage protection circuit is activated, shut down the input voltage, wait more than 3 minutes and turn on the AC input again to recover the output voltage. Recovery time varies depending on such factors as input voltage value at the time of the operation.

● **PBA600F, PBA1000F, PBA1500F and PBA1500T**

- In addition to a standard overvoltage protection circuit, an overvoltage protection circuit to follow to output voltage is built-in. If an output voltage exceeds a pre-set value, the overvoltage protection circuit to follow to output voltage is activated and shut down the output voltage.
*The Overvoltage protection circuit to follow to output voltage is optional for PBA300F.

Note :

- Please avoid applying a voltage exceeding the rated voltage to an output terminal. Doing so may cause a power supply to malfunction or fail. If you cannot avoid doing so, for example, if you need to operate a motor, etc., please install an external diode on the output terminal to protect the unit.
- In PBA600F, 1000F, PBA1500F and PBA1500T series, the overvoltage protection circuit is a tracking method in which the detec-

tion point is set depending on output voltage setting. However, even if a sensing line makes open or external voltage is applied to output terminal in order to activate the function at receiving inspection, the tracking function does not work, so the function is activated with higher value in a catalog.

Therefore, do not perform the function test to avoid the any trouble.

- The follow type overvoltage circuit doesn't operate when the remote sensing comes off. In this case, a standard overvoltage protection circuit operates. When the overvoltage protection circuit operates due to the breakdown of the power supply, it is similar. Standard overvoltage protection circuit is please contact us for details.

2.5 Thermal Protection

● **PBA300F, PBA600F, PBA1000F, PBA1500F and PBA1500T**

- A thermal protection circuit is built-in.
The thermal protection circuit may be activated under following conditions and shut down the output.
① When a current and a temperature continue to exceed the values determined by the derating curve.
② When a fan stops or air flow is blocked from the fan and weakens.

If the thermal protection circuit is activated, shut off the input voltage and eliminate all the overheating conditions. To recover the output voltage, have enough time to cool down the unit before turning on the input voltage again.

2.6 Output Voltage Adjustment

- To increase an output voltage, turn a built-in potentiometer clockwise. To decrease the output voltage, turn it counterclockwise.

● **PBA10F, PBA15F, PBW15F, PBA30F, PBW30F, PBA50F, PBW50F, PBA75F, PBA100F and PBA150F**

- We are offering an Option -V, which doesn't have a built-in potentiometer but instead enables you to adjust the output voltage by using an external potentiometer (please see 7 Options).

● **PBA300F, PBA600F, PBA1000F, PBA1500F and PBA1500T**

- The power supplies have an external output voltage control function. The output voltage can be adjusted within a 110% range from almost 0V by changing the voltage between the terminal TRM and the terminal -S on CN1. You can decrease the voltage by drawing a current from the TRM terminal. You can calculate the output voltage in this case from formula ① below.
Please note that the formula ① gives you only an estimate. Please contact us if you need accurate numbers.

$$\text{Output voltage} = \frac{\text{The voltage between TRM and -S}}{2.5 \text{ V}} \times \text{rated output voltage} \cdots \text{①}$$

Global Power Solutions

Please do not apply an external voltage of -0.7V or less or 3.0V or more.

There is more than one method to adjust the output voltage, including the methods to use external resistors and external power supplies. Since each method has different characteristic, please contact us for details.

■ If the terminal TRM opens while the external output voltage control function is in use, a unit generates the rated voltage.

If the terminal VB and the terminal -S are connected and the terminal TRM opens as shown in Fig.2.1, the unit stops generating the output voltage.

■ You can change the control voltage of TRM from 0 - 2.75V to 0 - 5.5V by serially connecting 1.73kΩ to the TRM terminal as shown in Fig.2.2.

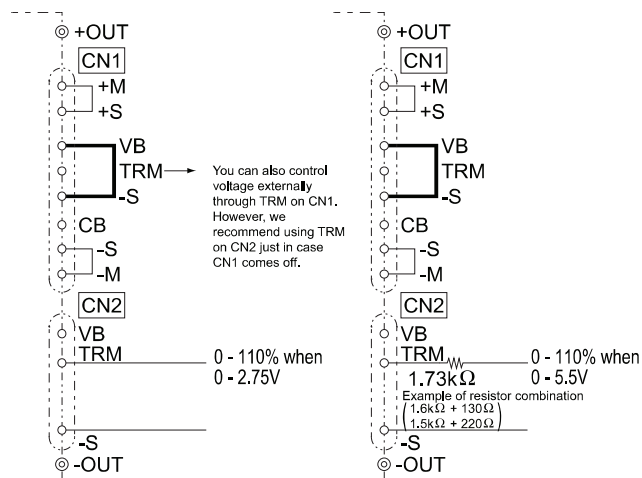

Fig.2.1 Wiring 1

(When TRM control voltage is 0 - 2.75V)

Fig.2.2 Wiring 2

(When TRM control voltage is 0 - 5.5V)

■ If the output voltage decreases to almost 0V, a fan may stop, output ripple may become large and PG signals may turn to "High."

■ Please do not change TRM voltage rapidly.

2.7 Remote ON/OFF

● PBA10F, PBA15F, PBW15F, PBA30F and PBW30F

■ These models do not have a remote ON/OFF function.

● PBA50F, PBW50F, PBA75F, PBA100F and PBA150F

■ Option -R is available to provide a remote ON/OFF function. Please see "7. Options" for details.

● PBA300F, PBA600F, PBA1000F, PBA1500F and PBA1500T

■ These models have a remote ON/OFF function.

You can operate the remote ON/OFF function by sending signals to CN1. Please see Table 2.1 for specifications and Fig.2.3 for connecting examples.

■ Remote ON/OFF circuits (RC2 and RCG) are isolated from input,

output, FG and AUX.

■ Please note the followings when using the remote ON/OFF function.

- ① The output stops when a current flows to RC.
- ② The current flow to RC is a 5mA type (maximum 12mA).
- ③ If the output voltage is turned off through the remote ON/OFF circuit, the built-in fan stops.

In the case of PBA300F, the fan slows down when the output voltage is turned off through the remote ON/OFF circuit.

- ④ If the output voltage is turned off through the remote ON/OFF circuit, PG signals turn to "High."
- ⑤ Description in this section is based on the assumption that you will use one unit alone. If you are planning to use the units in parallel operation or use multiple units for a single system, please check necessary voltage and current values.
- ⑥ If voltage or current of a value not listed in Table 2.1 is applied between RC2 and RCG, the output voltage may not be generated normally.

Table 2.1 Specifications of remote ON/OFF

Connection method	Fig.2.3 (a)	Fig.2.3 (b)	Fig.2.3 (c)
SW Logic	Output on	SW open (0.1mA max)	SW close (0.5V min)
	Output off	SW close (3mA min)	SW open (0.1mA max)
pin	RCG	AUXG	RCG, AUXG
Optional harness	·H-SN-20 (or H-SN-21)	·H-SN-20 (or H-SN-21)	·H-SN-20 (or H-SN-21) ·H-SN-22 Both needed ·H-SN-24 Both needed

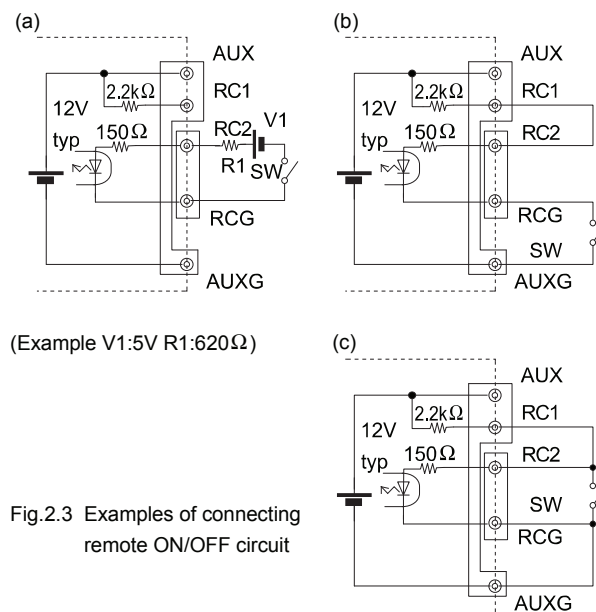

(Example V1:5V R1:620Ω)

Fig.2.3 Examples of connecting remote ON/OFF circuit

2.8 Remote Sensing

● PBA10F, PBA15F, PBW15F, PBA30F, PBW30F, PBA50F, PBW50F and PBA75F

■ These models do not have a remote sensing function.

● PBA100F and PBA150F

■ Option -K is available (for -3R3 and -5) to support a remote sensing function. Please see "7. Options" for details.

● PBA300F, PBA600F, PBA1000F, PBA1500F and PBA1500T

■ These models have a built-in remote sensing function.

If you do not use the remote sensing function, you can short out between +S and +M and between -S and -M on CN1.

When the power supplies are shipped from a factory, they come with a dedicated harness (H-SN-19) being mounted on CN1. If you do not use the remote sensing function, you can use the power supplies as they are.

■ Please see Fig.2.4 if you do not use the remote sensing function.

Please see Fig.2.5 if you use the remote sensing function.

■ When you use the remote sensing function, please wire from +S and -S on CN1. Harnesses are available for your purchase. Please contact us for details.

When you use the remote sensing, please note the followings.

- ① Wire carefully. When a connection of a load line becomes loose (due to such factors as loose screw), the load current flows to the sensing line and internal circuits of the power supply may be damaged.
- ② Use a sufficiently thick wire to connect between the power supply and the load and keep the line drop at 0.3V or below.
- ③ If the sensing line is long, connect C1 and R1.
- ④ Use a twisted pair wire or a shielded wire as the sensing line.
- ⑤ Do not draw the output current from +M, -M, +S or -S.
- ⑥ When the remote sensing function is used, the output voltage of the power supply may show an oscillating waveform or the output voltage may dramatically fluctuate because of an impedance of wiring and load conditions.

Please check and evaluate carefully before using the remote sensing function.

If the output voltage becomes unstable, we suggest you to try the followings.

- Remove the remote sensing line on the minus side and short out between -S and -M.
- Connect C1, R1 and R2.

Please contact us for details.

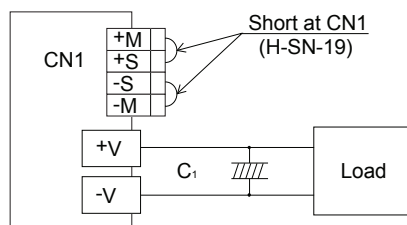

Fig.2.4 When not using remote sensing function

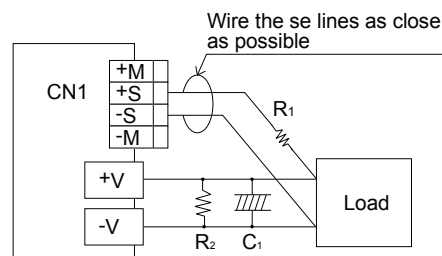

Fig.2.5 When using remote sensing function

2.9 Alarms

● PBA300F, PBA600F, PBA1000F, PBA1500F and PBA1500T

■ Alarms (PG signal) are generated from CN3. Please see Table 2.2 for the functions of the alarms. The objective of the PG signals is to detect whether or not a certain function of a power supply is working. It takes several seconds to generate the alarm signals and the timing when the alarm signals are generated is inconsistent. Please check if the objective of the alarm is achieved.

Table 2.2 Description of the alarms (PG signal)

Alarm	Output of Alarm
PG	Open collector method Good: Low (0.5V max at 10mA) Bad : High or Open 50V 10mA max
	The PG signals are "Low" when the power supply operates normally. The signals turn "High" when the fan stops or the power supply stops as a result of output voltage decrease/stop, activation of thermal protection, overvoltage protection or overcurrent protection functions. One of three phase is open (PBA1500T)

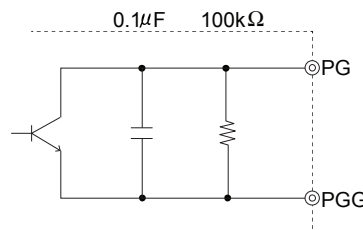

Fig.2.6 Internal circuit of PG

■ Please note the followings when you use the alarms (PG signal).

- ① The time it takes until the PG signals turn "High" vary depending on models and conditions.
PBA300F and PBA600F less than 1 second
PBA1000F, PBA1500F and PBA1500T less than 10 second
- ② If the output voltage is turned off through a remote ON/OFF circuit, the PG signals turn "High".
- ③ The PG signal may turn "High", if the output current of one unit becomes 10% or below of the rated current in parallel operation (in this case, the fan also stops).
- ④ If the output voltage is decreased to almost 0V or decreased rapidly through an external adjustment mechanism when load is light, The PG signal may turn "High".

- The PG signal (Alarm) circuit is isolated from input, output, FG, RC and AUX.

3 Peak Current

- PBA300F-24, PBA600F-24, PBA1000F-24, PBA1500F-24/36 and PBA1500T-24

- The units can generate the peak current under the following conditions.

- AC170 - 264V
- $t1 \leq 10$ [sec]
- $I_p \leq$ Rated peak current
- $I_{ave} \leq$ Rated current

· $Duty = \frac{t1}{t1+t2} \times 100$ [%] $\leq 35\%$

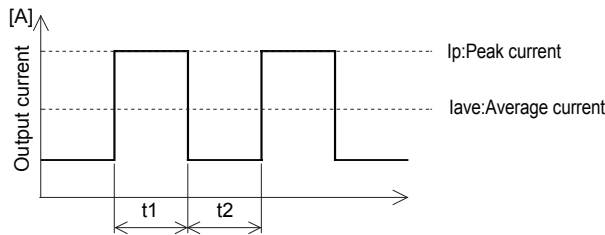

Fig.3.1 Peak current

4 Series/Parallel Operation

4.1 Series Operation

- You can use a power supply in series operation. The output current in series operation should be lower than the rated current of a power supply with the lowest rated current among power supplies that are serially connected. Please make sure that no current exceeding the rated current flows into a power supply.

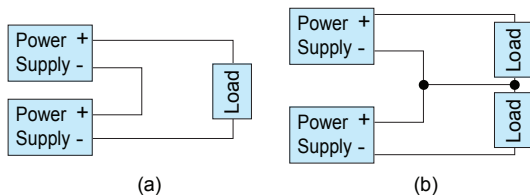

Fig.4.1 Examples of connecting in series operation

4.2 Parallel Operation/Master-slave Operation

- PBA10F, PBA15F, PBW15F, PBA30F, PBW30F, PBA50F, PBW50F, PBA75F, PBA100F and PBA150F

- Parallel operation is not possible.
- Redundancy operation is available by wiring as shown below.

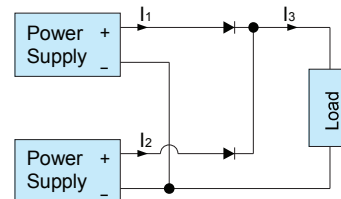

Fig.4.2 Example of connecting in redundancy operation

- Even a slight difference in output voltage can affect the balance between the values of I_1 and I_2 .

Please make sure that the value of I_3 does not exceed the rated current of a power supply.

$I_3 \leq$ rated current value

- PBA300F, PBA600F, PBA1000F, PBA1500F and PBA1500T

- You can use the power supplies in parallel operation by connecting units as shown in Fig.4.3.

Please parallelly connect $\pm S$, VB and CB of each power supply in parallel operation and connect $\pm S$ and $\pm M$ on CN1 of the master power supply.

When the power supplies are shipped from a factory, they come with a dedicated harness (H-SN-19) being mounted on CN1.

Please remove the dedicated harness (H-SN-19), which is mounted on CN1 of the slave power supply, and use an optional harness, H-PA-3, to connect $\pm S$, VB and CB parallelly.

Differences in the output current values among the power supplies in parallel connection are 10% at most. Please make sure that the sum of the output current values does not exceed a value obtained from the right side of the following equation.

(Output current in parallel operation)
= (Rated current per unit) X (Number of units) X 0.9

- When the number of units in parallel operation increases, the input current also increases. Please design input circuitry (including circuit pattern, wiring and current capacity for equipment) carefully.

- Please make sure that the wiring impedance of a load from each power supply becomes even. Otherwise, the output current balance circuit may become inoperative.

- The maximum number of units you can use in parallel operation is 5.

■ You can adjust the output voltage in parallel operation by adjusting a potentiometer of just one power supply.

To do so, select one power supply as the master unit and turn the potentiometers of the other (slave) power supplies clockwise to the end.

Once you have done this, you can adjust the output voltage by turning the potentiometer of the master unit.

■ If you use the remote sensing function in parallel operation, connect parallelly +S and -S of slave power supplies must be connected to master and connect the sensing wire from the master unit to the load.

■ You cannot parallelly operate power supplies with different output voltage or electrical power.

■ If an output stops (through the remote ON/OFF circuit or due to an input shutoff or failure) in parallel operation, the LED of the stopped unit lights off.

■ When the output current of one unit becomes 10% or less of the rated current, the PG signals may turn "High" and the fan may stop.

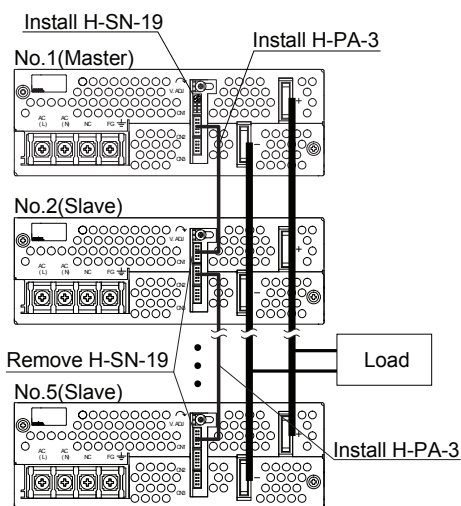

Fig.4.3 Example of parallel connection (PBA1500F)

4.3 N+1 Parallel Redundancy Operation

● PBA300F, PAB600F, PBA1000F, PBA1500F and PBA1500T

■ You can have N+1 redundancy operation for improved system reliability.

■ If you add one extra power supply in parallel operation, even if one of the power supplies in your system fails, the remaining non-failed power supplies continue to sustain the system. If one of the power supplies stops operating, the output voltage may change about 5%.

■ When unit replacement is required due to unit failure, input voltage for all units must be cut off.

■ After replacement, please make sure that all wirings are completed correctly, before re-applying input voltage.

■ Hot-swap or Hot-plug is not available.

■ If 2 or more units failed, sufficient power could not be provided to the system. Therefore, please replace the failed unit immediately in case where unit failure is found.

■ If you have any questions about series, parallel and N+1 redundancy operations, please contact us.

5 Assembling and Installation

5.1 Installation

■ Do not insert a screw more than 6mm from the outside of a power supply to keep enough insulation distance between the screw and internal components.

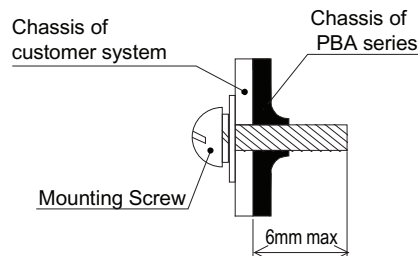

Fig.5.1 Mounting screw

● PBA10F, PBA15F, PBW15F, PBA30F, PBW30F, PBA50F, PBW50F, PBA75F, PBA100F and PBA150F

■ If you use two or more power supplies side by side, please keep a sufficient distance between them to allow enough air ventilation. Ambient temperature around each power supply should not exceed the temperature range shown in the derating curve.

● PBA300F, PAB600F, PBA1000F, PBA1500F and PBA1500T

■ The power supplies have a built-in forced cooling fan. Do not block ventilation at the suction side (terminal block side) and its opposite side (fan installation side).

If you need to secure a power supply by screws, securely fix it, taking into consideration of its weight. You can install it in any direction.

■ If you use a power supply in a dusty environment, it can give a cause for a failure. Please consider taking such countermeasures as installing an air filter near the suction area of the system to prevent a failure.

■ In PBA300F, PBA1500F and PBA1500T, ventilation holes are located on the mounting side. If you would like to install the unit by using that side, please contact us for details.

5.2 Derating

- PBA10F, PBA15F, PBW15F, PBA30F, PBW30F, PBA50F, PBW50F, PBA75F, PBA100F and PBA150F

■ Mounting Method

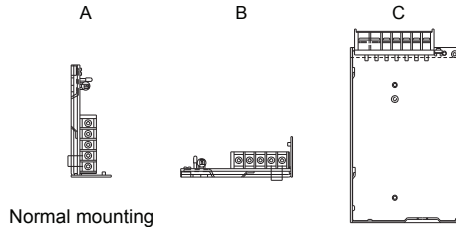

■ Derating Curve

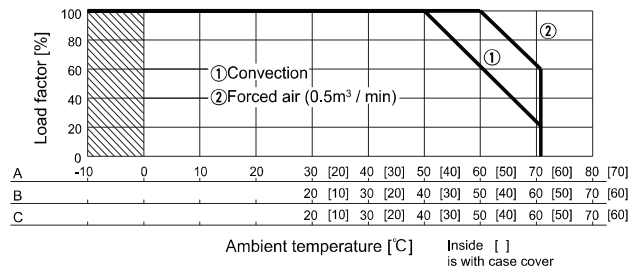

*Specifications for ripple and ripple noise changes in the shaded area.

- PBA10F, PBA15F, PBW15F, PBA30F and PBW30F

■ Input Voltage Derating Curve

Input voltage derating curve is shown in Fig.5.2.

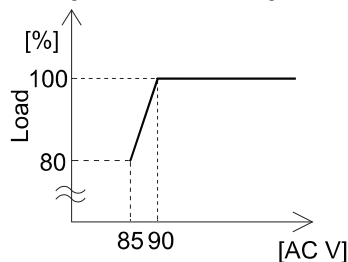

Fig.5.2 Input voltage derating curve

■ Standard for Cooling

- PBA10F, PBA15F, PBW15F, PBA30F, PBW30F, PBA50F, PBW50F, PBA75F, PBA100F and PBA150F

■ Please make sure that the temperature of Point A (see External View) falls under a temperature specified in Table 5.1.

■ The temperatures shown in Table 5.1 for PBA10F, PBA15F, PBW15F, PBA30F and PBW30F are those for their capacitors.

■ Point A is engraved on the chassis of PBA50F, PBW50F, PBA75F, PBA100F and PBA150F.

Table 5.1 Temperatures of Point A

Model Name	Point A	
	Ambient Temperature: 50°C	Ambient Temperature: 71°C
PBA10F	58°C or less	74°C or less
PBA15F and PBW15F	64°C or less	73°C or less
PBA30F and PBW30F	73°C or less	82°C or less
PBA50F and PBW50F	72°C or less	82°C or less
PBA75F	83°C or less	84°C or less
PBA100F	87°C or less	83°C or less
PBA150F	89°C or less	85°C or less

- PBA300F, PAB600F, PBA1000F, PBA1500F and PBA1500T

■ Ambient Temperature Derating Curve

Derating curve depending on an ambient temperature (temperature of air sucked in for a cooling purpose) is shown in Fig.5.3.

*Specifications for ripple and ripple noise changes in the shaded area.

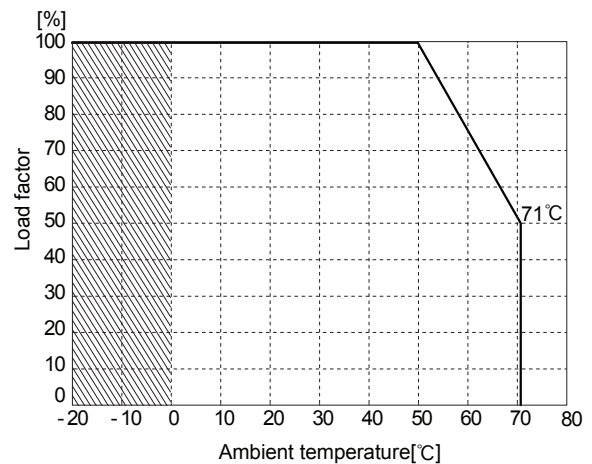

Fig.5.3 Ambient temperature derating curve

- PBA1500F

■ Input Voltage Derating Curve

Input voltage derating curve is shown in Fig.5.4.

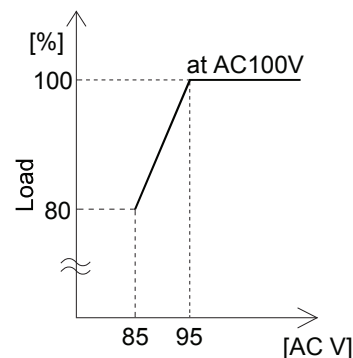

Fig.5.4 Input voltage derating curve

5.3 Expected Life and Warranty

■Expected Life

Please see the following tables for expected life.

- PBA10F, PBA15F, PBW15F, PBA30F, PBW30F, PBA50F, PBW50F, PBA75F, PBA100F and PBA150F

Mounting Method	Annual Average of Ambient Temperatures	Load Factor	
		50%	100%
A	Ta = 30°C or less	10 years or more	10 years or more
	Ta = 40°C	10 years or more	6 years
	Ta = 50°C	5 years	3 years
B and C	Ta = 20°C or less	10 years or more	10 years or more
	Ta = 30°C	10 years or more	6 years
	Ta = 40°C	5 years	3 years

- PBA300F, PAB600F, PBA1000F, PBA1500F and PBA1500T

All Mounting Methods	Annual Average of Ambient Temperatures	Load Factor	
		50%	100%
	Ta = 40°C or less	7 years*	7 years*
	Ta = 50°C	6 years*	5 years

*Values with * are based on the assumption that fan maintenance will be properly done.

- PBA300F, PAB600F, PBA1000F, PBA1500F and PBA1500T

■Fans should be exchanged on a regular basis because their life expectancy (R (t) = 90%) vary depending on use conditions as shown in Fig.5.5. Please see "Optional Parts" for details about fan units.

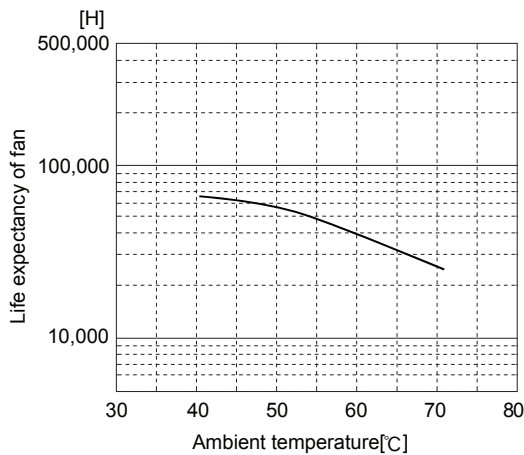

Fig.5.5 Life expectancy of fan

■Warranty

- PBA10F, PBA15F, PBW15F, PBA30F, PBW30F, PBA50F, PBW50F, PBA75F, PBA100F and PBA150F

Mounting Method	Annual Average of Ambient Temperatures	Load Factor	
		50%	100%
A	Ta = 40°C or less	5 years	5 years
	Ta = 50°C	5 years	3 years
B and C	Ta = 30°C or less	5 years	5 years
	Ta = 40°C	5 years	3 years

- PBA300F, PAB600F, PBA1000F, PBA1500F and PBA1500T

■The warranty period is 5 years if a power supply is used within a derating curve.

6 Others

6.1 Output Current Monitor

- PBA300F, PBA600F, PBA1000F, PBA1500F and PBA1500T

■You can monitor an output current by measuring a voltage between the terminal CB and the terminal -S on either CN1 or CN2.

■Fig.6.1 shows the relationship between the voltage of the terminal CB and the output current.

Fig.6.1 shows a typical characteristic of PBA1500F-5. Please contact us for the characteristics of the other models.

The output current shown in Fig.6.1 should be used only as a guide.

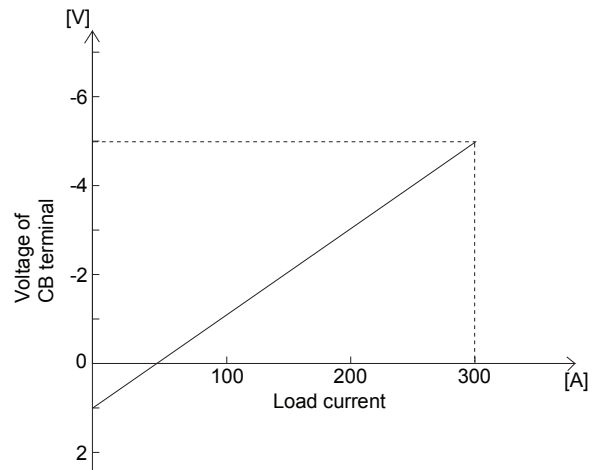

Fig.6.1 Load current conversion graph(PBA1500F-5)

Global Power Solutions

- Please note the followings when measuring the voltage of the terminal CB.
 - Wire carefully to avoid malfunction caused by noise.
 - Use a measuring instrument whose input impedance is 500kΩ or more.
 - Do not short-circuit between CB terminal and -S terminal. Doing so could cause a failure.

6.2 External Capacity

● PBA10F, PBA15F, PBW15F, PBA30F and PBW30F

- When a capacitor with large capacity is connected to the load side, a power supply may stop or start hunting. Please contact us for details.

6.3 Isolation

- When you run a Hi-Pot test as receiving inspection, gradually increase the voltage to start. When you shut down, decrease the voltage gradually by using a dial. Please avoid a Hi-Pot tester with a timer because, when the timer is turned ON or OFF, it may generate a voltage a few times higher than the applied voltage.
- When you test a unit for isolation between the input and output or between the output and the terminal FG, short-circuit between the output and the terminals RCG, PGG and AUXG.

6.4 Auxiliary Power (AUX)

● PBA300F, PBA600F, PBA1000F, PBA1500F and PBA1500T

- The power supplies can generate an auxiliary power (AUX: 12V 0.1A) from CN3 to provide for remote ON/OFF and attached circuits.
- AUX circuit is isolated from other (input, output, FG, RC and PG) circuits.
- Please do not draw a current of 0.1A or higher from the auxiliary power because doing so could damage the internal circuits or cause malfunction.
When you connect a DC-DC converter, a current a few times higher than normal current may flow at start-up. Please check the current.

6.5 External Component (EMI/EMC Filter)

● PBA1500F and PBA1500T

- You can have the power supplies comply with FCC Part 15 class B and EN55022-B by connecting an external EMI/EMC Filter.

Recommended EMI/EMC Filter
PBA1500F : NAC-20-472 (COSEL)
PBA1500T : TAC-10-683 (COSEL)

7 Options

7.1 Outline of Options

- * Please inquire us for details of specifications and delivery timing.
- * You can combine multiple options. Some options, however, cannot be combined with other options. Please contact us for details.

● -C

- Option -C units have coated internal PCB for better moisture resistance.

● -E and -G

- Options -E and -G units are low leakage current type.
- Differences from standard versions are summarized in Table 7.1.

Table 7.1 Low leakage current type

	-E*	-G
Leakage Current (AC240V)	0.5mA max	0.15mA max
Conducted Noise	Class A	N/A
Output Ripple Noise	150% of standard units	200% of standard units

*PBA50F, PBW50F, PBA75F, PBA100F and PBA150F

● -U(PBA300F, PBA600F, PBA1000F, PBA1500F and PBA1500T)

- Operation stop voltage of Option -U units is set at a lower value than that of a standard version to support low input voltage.
- Use Conditions

		Output	
PBA300F	125W (83W)	PBA1000F	500W (330W)
PBA600F	250W (165W)		
Input AC50V (DC70V) Duty 1s/30s			

		Output	
PBA1500F	750W (495W)	PBA1500T	750W
		Input AC50V(DC70V)	Input AC100V 3 φ
Duty 1s/30s			

- * Please avoid using continuously for more than 1 second under above conditions. Doing so may cause a failure.

● -F1 (PBA600F, PBA1000F, PBA1500F and PBA1500T)

- Option -F1 units have a longer-life fan instead of a standard fan. This option is not available for PBA300F.
- Differences from standard versions are summarized in Fig.7.1 (Life expectancy of fan).
- Appearance of PBA600F changes in Option -F. Please see External View for details.

Global Power Solutions

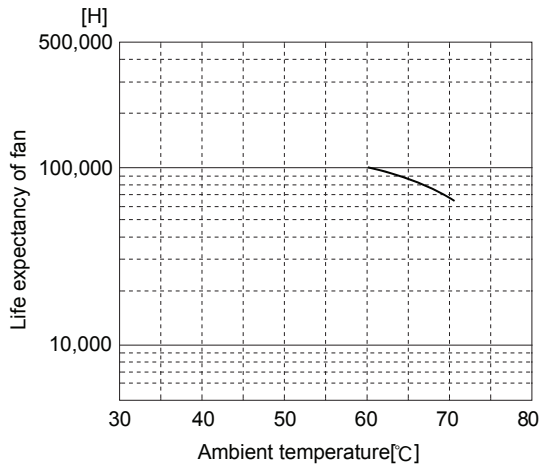

Fig.7.1 Life expectancy of long-lived fan

● **-F3 (PBA300F, PBA600F, PBA1000F, PBA1500F and PBA1500T)**

- Option -F3 units have a reverse air fan instead of a standard fan.
- Differences from standard versions are summarized in Fig.7.2 and Fig.7.3.
- Please contact us for details about life expectancy of fan.



Fig.7.2 Air flow(-F3)

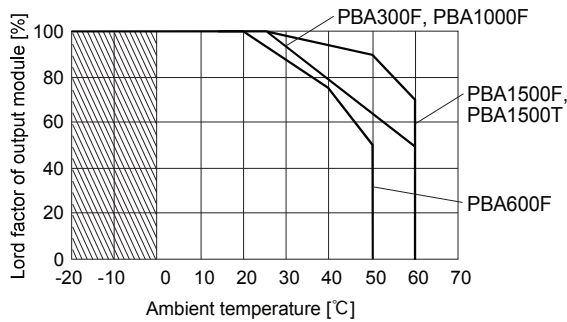

Fig.7.3 Ambient temperature derating curve (-F3)

● **-F4 (PBA300F, PBA600F, PBA1000F, PBA1500F and PBA1500T)**

- Option -F4 units have a low-speed low-noise fan instead of a standard fan.
- Differences from standard versions are summarized in Fig.7.4.

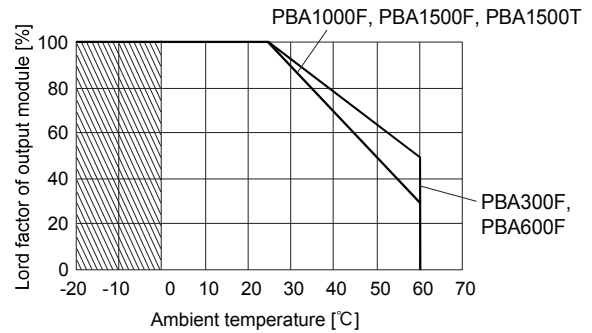

Fig.7.4 Ambient temperature derating curve (-F4)

● **-T (PBA10F, PBA15F, PBW15F, PBA30F, PBW30F, PBA50F, PBW50F, PBA75F, PBA100F and PBA150F)**

- Option -T units have vertically positioned screws on a terminal block.
- Please contact us for details about appearance.

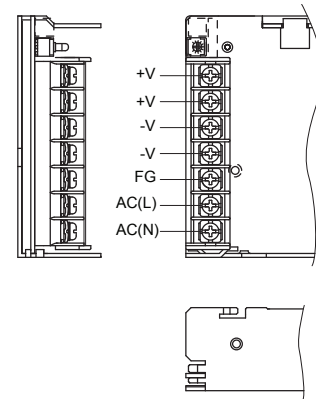

Fig.7.5 Example of option -T (PBA100F)

● -J (PBA10F, PBA15F, PBW15F, PBA30F, PBW30F, PBA50F, PBW50F, PBA75F, PBA100F and PBA150F)

- Option -J units have Molex connectors instead of a terminal block.
- Dedicated harnesses are available for your purchase. Please see Optional Parts for details.
- Please contact us for details about appearance.
- For PBA100F and PBA150F, this option is available in -12, -15, -24, -36 and -48 types.
- Please do not apply more than 5A per 1 pin.

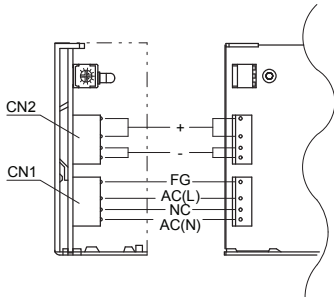

Fig.7.6 Image of option -J (PBA50F)

(1) Matching Molex Connectors and Terminals for PBA10F, PBA15F, PBW15F, PBA30F, PBW30F, PBA50F and PBW50F.

I/O Connector	Matching Housing	Terminal
CN1	10-31-1048	10-63-3044
		Reel : 08-70-1031 Loose : 08-70-1030
CN2	09-65-2049	09-50-1043
		Reel : 08-70-1031 Loose : 08-70-1030

(2) Matching Molex Connectors and Terminals for PBA75F, PBA100F and PBA150F.

I/O Connector	Matching Housing	Terminal
CN1	10-31-1048	10-63-3044
		Reel : 08-70-1031 Loose : 08-70-1030
CN2	09-65-2069	09-50-1063
		Reel : 08-70-1031 Loose : 08-70-1030

● -R (PBA50F, PBW50F, PBA75F, PBA100F and PBA150F)

- You can control output ON/OFF remotely in Option -R units. To do so, connect an external DC power supply and apply a voltage to a remote ON/OFF connector, which is available as option.

Model Name	Built-in Resistor Ri [Ω]	Voltage between RC (+) and RC (-) [V]		Input Current [mA]
		Output ON	Output OFF	
PBA50F, PBW50F, PBA75F, PBA100F and PBA150F	780	4.5 - 12.5	0 - 0.5	(20max)

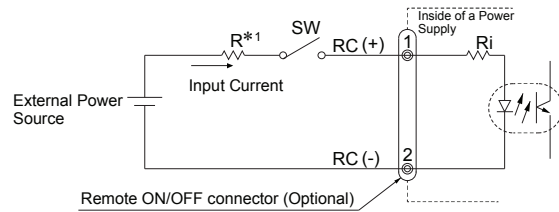

Fig.7.7 Example of using a remote ON/OFF circuit

- Dedicated harnesses are available for your purchase. Please see Optional Parts for details.
- *1 If the output of an external power supply is within the range of 4.5 - 12.5V, you do not need a current limiting resistor R. If the output exceeds 12.5V, however, please connect the current limiting resistor R.

To calculate a current limiting resistance value, please use the following equation.

$$R[\Omega] = \frac{V_{cc} - (1.1 + R_i \times 0.005)}{0.005}$$

- * Please wire carefully. If you wire wrongly, the internal components of a unit may be damaged.
- Remote ON/OFF circuits (RC+ and RC-) are isolated from input, output and FG.

● -N (PBA10F, PBA15F, PBW15F, PBA30F, PBW30F, PBA50F, PBW50F, PBA75F, PBA100F and PBA150F)

- Option -N units come with a cover.
- Appearance of Option -N units is different from that of standard units. Please see External View for details.
- Derating curve for Option -N units is different from that for standard units. Please see 5.2 Derating Curve for details.
- UL508 is acquired (5V/ 12V/ 24V type in PBA10F/ PBA15F/ PBA30F with -N option, only 24V type in PBA50F/ PBA75F/ PBA100F/ PBA150F with -N option).
- * Safety agency approvals will be void if the cover is attached after the unit is ex-factoryed.

● -N1 (PBA10F, PBA15F, PBW15F, PBA30F, PBW30F, PBA50F, PBW50F, PBA75F, PBA100F and PBA150F)

- Option -N1 units come with a dedicated DIN rail attachment.
- Please contact us for details about appearance.
- Option -N1 units come with a cover (Option -N).
- Each model has its own vibration and shock specifications.

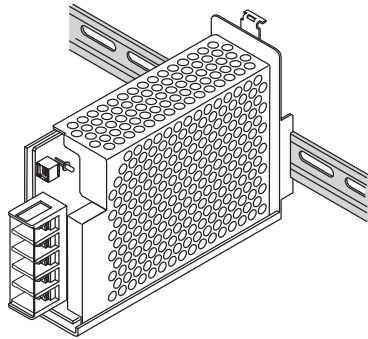

Fig.7.8 Power supply installed on a DIN rail

*External views are different among models.

● **-V (PBA10F, PBA15F, PBW15F, PBA30F, PBW30F, PBA50F, PBW50F, PBA75F, PBA100F and PBA150F)**

- Option -V units have connector for external potentiometer instead of a built-in potentiometer.
- Appearance of Option -V units is different from that of standard units. Please contact us for details.
- If power is turned on while CN5 is open, output voltage decreases significantly.

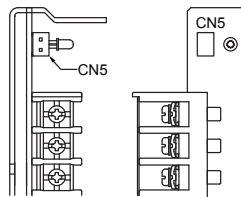

Fig.7.9 Upper view of option -V

● **-K (PBA100F/PBA150F/-3R3/-5 Only)**

- Option -K units have a remote sensing function. Please note that this option is not available for all models.
- Please contact us for details.