

Ver 3.0



KRS 系列伺服电机驱动器

KRS Servo drives

技术手册

Technical manuals





台州亿丰电子有限公司

Taizhou Yifeng Electronics co., LTD

安全注意事项 Safety Caution

为确保安全使用本产品，必须遵守下列安全标志，以免伤害人员，损坏设备。

In order to ensure the safe use of this product, must observe the following safety signs, in order to avoid damaging to the people and the equipment .

 警告 warning	表示错误操作可引发危险，导致轻度或中度人身伤害，损坏设备，甚至引发火灾。 Said wrong operation will trigger dangerous, leading to mild or moderate personal injury, damage to equipment, and even fire.
 危险 dangerous	表示错误操作引发危险，导致伤害或死亡。 Said wrong operation will trigger dangerous ,cause injury or death
	表示禁止操作。 Said Prohibit operation
	表示必须操作。 Said must operate

产品到达后，进行确认、安装、配线、运行维护、检查时，以下是必须遵守的重要事项：

After the product arriving, when validation, installation, wiring, operation maintenance, inspection of the product, the following is one of the important matters must abide by:

- 安装时注意事项：Matters needing attention during installation

 警告 Warning
<p>严禁安装在潮湿及会发生腐蚀的环境、有易燃性气体的环境下、可燃物的附近及灰尘、金属粉末较多的环境，否则有可能会发生触电和火灾。 It is forbidden to install will happen in the damp and corrosion environment, a flammable gas environment, and near combustibile dust and metal powder more environment, or you may get an electric shock and fire.</p>

- 配线时的注意事项：Matters needing attention during installation wiring

 警告 Warning
<p>▲ 伺服驱动器的接地端子必须接地，否则，可能会发生触电和火灾。 The earthing terminal of the servo drive must be grounded, otherwise, will get an electric shock and fire could occur</p> <p>▲ 严禁把伺服驱动器的输出端子 U， V， W ，连接至三相电源，否则，可能受伤和引发火灾。 It is forbidden to put the output terminal of the servo drive, U, V, W, connected to a three-phase power supply, otherwise, could be injured and fire</p> <p>▲ 严禁把220V驱动器连接至380V电源，否则可以触电和引发火灾。</p>

It is strictly prohibited to connect the 220v driver to 380 v, 220 v power supply, or you may get an electric shock and fire

▲ 务必将电源端子、电机输出端子拧紧，否则有可能会引发火灾。

Be sure to tighten power terminal, motor output terminal, otherwise may cause a fire

● 运行时的注意事项：The matters needing attention when running



危险

Dangerous

▲ 在运行中，严禁触摸任何旋转部件，否则可能会受伤。In the operation, it is forbidden to touch any rotating parts, or you might get hurt

▲ 在运行中，严禁触摸电机和驱动器，否则可能会烫伤。In the operation, it is forbidden to touch electric motor and drive, otherwise you may burn



警告

Warning

▲ 在运行前，必须选择好正确的电机型号，否则可能人员受到伤害，损伤设备。

Before operating, must choose the right motor type, otherwise people will be hurt and the equipment will be damaged.

▲ 在运行前，必须设置好与应用场合相适应的用户参数，否则可能受到伤害，损伤设备。

Before operating, you must set right parameters and applications that meet the needs of users, or may be hurt, damage to equipment

▲ 在运行前，确认机械是否可随时紧急停止，否则，可能会受伤。

Before operating, confirm whether the mechanical may at any time the emergency stop, otherwise, you might get hurt.

● 保养检查时的注意事项：Maintain the points for attention during the inspection



▲ 严禁触摸伺服驱动器的内部，否则有可能触电。

It is forbidden to touch the inside of the servo drive, or you may get an electric shock

▲ 关闭电源后，在5分钟内，严禁触摸端子，否则，残留的电压可能会导致触电。

When turn off the power, in the five minutes, do not touch terminals, otherwise, the residual voltage may cause electric shock

▲ 严禁拆装伺服电机，否则有可能触电。

It is forbidden to tear open outfit servo motor, or you may get an electric shock

目 录 CATALOGUE

第一章 产品检查及安装 1

Chapter 1 Product inspection and installation.....1

1.1 产品检查 PRODUCT INSPECTION..... 1

1.2 产品铭牌 PRODUCT BRAND..... 2

1.3 产品前面板 THE FRONT PANEL OF PRODUCT 2

1.4 驱动器技术规格 DRIVE TECHNOLOGY SPECIFICATIONS..... 4

1.5 伺服电机安装 SERVO MOTOR INSTALLATION..... 5

1.6 电机旋转方向 THE MOTOR DIRECTION OF ROTATION 6

1.7 KRS 系列驱动器与电机型号适配 THE KRS SERIES DRIVE AND MOTOR MODEL ADAPTATION..... 7

第二章 接线 CHAPTER 2 WIRING 8

2.1 系统组成与接线 THE SYSTEM COMPOSITION AND WIRING 8

2.2 CN1 通信接口 CN1 COMMUNICATION INTERFACE 11

2.3 CN2 控制接口 CN2 CONTROL INTERFACE..... 13

2.4 CN3 编码器接口 CN3 ENCODER INTERFACE 18

2.3 标准接线 THE STANDARD WIRING..... 19

第三章 面板操作 CHAPTER 3 PANEL OPERATION ... 21

3.1 面板组成 PANELS.....	21
3.2 模式功换 MODE SWITCH	21
3.3 监控模式操作 MONITORING MODE OPERATION.....	22
3.4 辅助模式操作 AUXILIARY MODE OPERATION	22
3.5 用户参数模式操作 USER PARAMETER MODE OPERATION	30

第四章 功能参数 CHAPTER 4 FUNCTION PARAMETERS 31

4.1 参数设置面板操作 PARAMETER SETTINGS PANEL	31
4.2 参数一览表 PARAMETER LIST.....	32
4.3 参数详解 PARAMETERS	44
4.4 端口功能详解 PORT FUNCTIONS.....	87

第五章 监控参数与操作 CHAPTER 5 MONITORING PARAMETERS AND OPERATION 92

5.1 监控面板操作 MONITOR PANEL OPERATION	92
5.2 监控参数一览表 MONITOR THE PARAMETER LIST	93

第六章 报警及处理 CHAPTER 6 ALARM AND PROCESSING..... 94

6.1 报警清除操作 ALARM CLEARANCE OPERATION	94
6.2 警报内容与对策表 ALARM CONTENT AND COUNTERMEASURE.....	94

第七章 MODBUS 通信功能 CHAPTER 7 MODBUS COMMUNICATION

FUNCTION 100

7.1 MODBUS 通信简介 MODBUS COMMUNICATION INTRODUCTION 100

7.2 通信协议结构 COMMUNICATION PROTOCOL STRUCTURE 101

7.3 常用命令码 COMMONLY USED COMMAND CODE 103

7.4 伺服参数、状态信息通信地址 THE SERVO PARAMETERS, THE STATE INFORMATION COMMUNICATION ADDRESS 115

附录 THE APPENDIX 116

附录 A 增益切换 APPENDIX A GAIN SWITCH 116

附录 B 控制模式切换 APPENDIX B CONTROL MODE SWITCH 116

附录 C 伺服驱动器工作时序 APPENDIX C SERVO DRIVER WORK SEQUENCE 120

附录 D 电磁制动器 APPENDIX D ELECTROMAGNETIC BRAKE 121

附录 E 再生制动电阻 APPENDIX E REGENERATIVE BRAKING RESISTOR 122

附录 F 原点回归 APPENDIX F ORIGIN POINT 123

附录 G 内部位置控制 APPENDIX G INTERNAL POSITION CONTROL 131

第一章 产品检查及安装

Chapter One products inspection and installation

1.1 产品检查 Product inspection



本产品出厂前均做过完整功能测试，为防止产品运送过程中因疏忽导致产品不正常，拆封后请详细检查下列事项：

This product has made the complete function test before the leaving the factory, to prevent the product in the course of transportation for negligence resulted in the product (s) is not functioning properly. Once opened, please check the detailed the following matters:

- 检查伺服驱动器与伺服电机型号是否与订购的机型相同。
- check the servo drive and servo motor type with the same whether order model
- 检查伺服驱动器与伺服电机外观有无损坏及刮伤现象。运送中造成损伤时请勿接线送电。Check the appearance of the servo drive and servo motor whether there is any damage and scratches phenomenon. If there is any damage during the shipment, please don't wire power transmission.
- 检查伺服驱动器与伺服电机有无零组件松脱之现象。是否有松脱的螺丝，是否螺丝未锁紧或脱落。Check the servo drive and servo motor if there is any loose parts and other phenomenon. If there is a loose screw, screw not lock or fall off
- 检查伺服电机转子轴是否能以手平顺旋转。带制动器的电机无法直接旋转。Check the servo motor rotor shaft can be smooth rotation. The motor with brake cannot be directly rotation

如果上述各项有了生故障或不正常的现象，请立即与经销商联系。If there is any fault or unmoral phenomenon, please contact with dealers immediately

1.2 产品铭牌 ID label

 克瑞斯伺服驱动器 KRS AC SERVO DRIVER		 危险 请按照说明书安装、接线、使用，务必可靠接地。  高压电源 通电时及切断电源5分钟之内，请不要对驱动器进行拆装、以防触电。
型号	ASDD-30A	
电压	AC220V/50-60HZ	
输出电流	30A	
生产日期		

1.3 产品前面板 The front panel

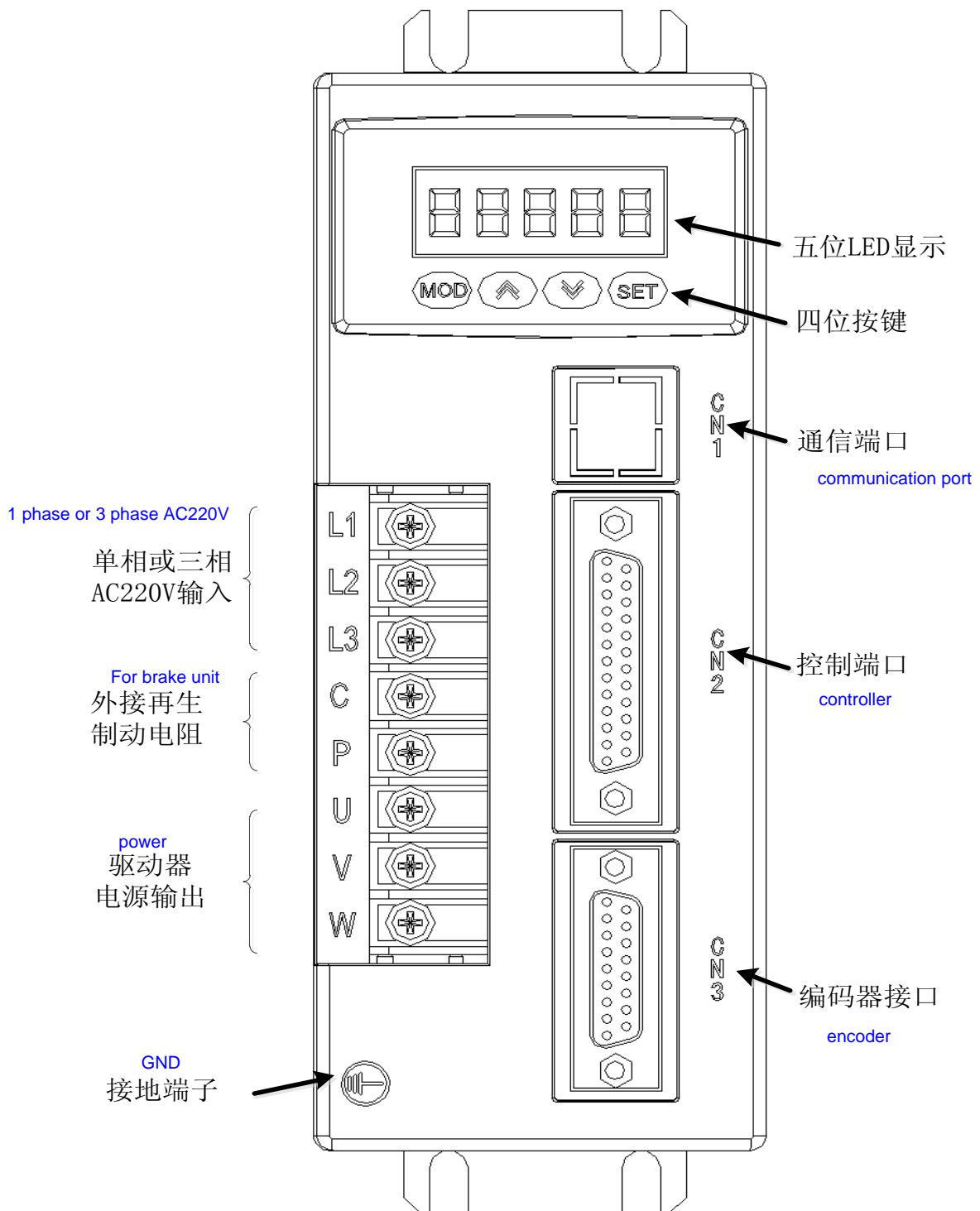

1.4 驱动器技术规格 The function of AC servo motor driver.

输入电源 The input power		单相或三相AC220V -15~+10% 50 / 60Hz Single phase or three phase AC220V -15~+10% 50 / 60Hz
环境 environme nt	温 度 temper ature	工作: 0~55 °C 存储: -20°C~80°C Using: 0~55°C Storage: -20°C~80°C
	湿度 humidity	小于90% (无结露) Below 90% RH No dewing
	振动 vibration	小于0.5G(4.9m/S ²), 10~60Hz (非连续运行) Belown0.5G(4.9m/S ²), 10-60 no continue running
控制方式 Control mode		IGBT PWM 正弦波控制 IGBT PWM sine wave control
控制模式 Control mode		① 转矩模式 (内部或外部) Torque mode (internal or external) ② 速度模式 (内部或外部) speed mode (internal or external) ③ 位置模式 (内部或外部) Position mode (internal or external) ④ 位置/速度模式 Position/velocity model ⑤位置/转矩模式 Position/torque model ⑥速度/转矩模式 Speed/torque model
控制输入 Control input		伺服使能 servo enables、报警复位 alarm reset、正转驱动禁止 Forward driving is prohibited、反转驱动禁止 Reverse driving is prohibited、 外部正转转矩限制 External forward torque is limited、外部反转转矩限制 external reverse torque is limited、紧急停机 Emergency stop、零速 Zero speed clamp、 内部速度指令选择 1 Internal speed command option 1、内部速度指令选择 2 Internal speed command option 2 内部速度指令选择 3 Internal speed command option 3、内部转矩指令选择 1 The internal torque command option 1、 内部转矩指令选择 2 The internal torque command option 2、控制模式切换 Control mode switch、增益切换 Gain switch、 电子齿轮分子选择 1 Electronic gear molecular option 1、电子齿轮分子选择 2 Electronic gear molecular option 2、指令取反 Instructions for、 位置偏差清除 Position deviation to clear、脉冲输入禁止 Pulse input is prohibited、比例控制 Proportional control、原点回归触发 The origin return to trigger、

	原点回归参考点 The origin return reference point、内部位置选择 1 Internal location option 1、内部位置选择 2 Internal location option 2、 触发内部位置指令 Trigger internal position command、暂停内部位置指令 Suspend internal position command
控制输出 Control the output	报警检出 Alarm detection、伺服准备好 Servo ready、紧急停止检出 Emergency stop checked out、定位完成 Positioning to complete、速度到达 Speed to reach、到达预定转矩 Reach the predetermined torque、零速检测 Zero speed detection、伺服电机通电 Servo motor current、电磁制动 Electromagnetic brake、原点回归完成 The origin return to complete、定位接近 Located close to、转矩限制中 torque limit、速度限制中 speed limit、跟踪转矩指令到达 Tracking arrive torque command
编码器反馈 The encoder feedback	2500p/r , 15线增量型, 差分输出 2500p/r, 15 line increment model, differential output
通信方式 Communication mode	RS-232 或 RS-485 RS-232 OR RS-485
显示与操作 Display and operation	① 5位LED显示five LED display ②4个按键Four buttons
制动方式 Braking way	通过内置/外接制动电阻进行能耗制动 Through the internal/external braking resistance braking energy
冷却方式 Cooling way	风冷(热传导膜具、高速强冷风扇) Air cooled (heat transfer film, the strong cold wind fan)
功率范围 Power range	≤7.5KW

1.5 伺服电机安装 Servo motor installation

1.4.1 安装环境条件 Installation environment conditions

- 工作环境温度：0~40℃；工作环境湿度：80%以下（无结露）。Working environment: 0~ and ℃; working environment: less than 80% (no condensation)
- 贮存环境温度：-40~50℃；贮存环境湿度：80%以下（无结露）。Storage environment temperature: - ℃; Storage environment humidity: 80% of the (no condensation)
- 振动：0.5G 以下。Vibration: Below 0.5 G
- 通风良好、少湿气及灰尘之场所。Well ventilated, less moisture and dust place

- 无腐蚀性、引火性气体、油气、切削液、铁粉等环境。No corrosive, flash gas, oil and gas, cutting fluid, iron powder and so on environment
- 无水汽及阳光直射的场所。No moisture and direct sunlight place

1.4.2 安装方法 Installation method

- 水平安装: 为避免水、油等液体自电机出线端流入电机内部, 请将电缆出口置于下方。Level installation: to avoid liquids such as water, oil from motor wire end into the motor internal, please will cable outlet in below
- 垂直按装: 若电机轴朝上安装且附有减速机时, 须注意并防止减速机内的油渍经由电机轴渗入电机内部。Vertical installation: if the motor shaft and the installation with reduction unit, must pay attention to and prevent reducer in mark through the motor shaft into the motor internal
- 电机轴的伸出量需充分, 若伸出量不足时将容易便电机运动时产生振动。The motor shaft out quantity must be thoroughly, if insufficient out to motor sports generates vibration
- 安装及拆卸电机时, 请勿用榔头敲击电机, 否则容易造成电机轴及编码器损坏。Installation and remove the motor, please do not use hammer knock motor, otherwise easy to cause damage to the motor shaft and encoder

1.6 电机旋转方向 The motor direction of rotation

从电机负载端看, 电机轴伸逆时针旋转 (CCW) 为正转, 顺时针旋转 (CW) 为反转。
Looking from the motor load on the motor shaft and counterclockwise (CCW) for the forward, clockwise (the CW) as the reverse

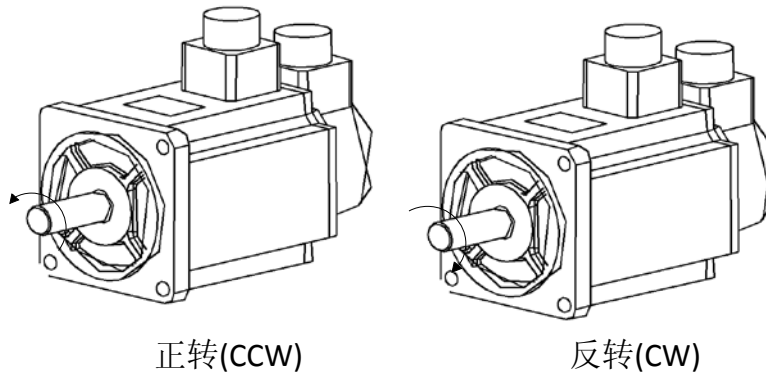

1.7 KRS 系列驱动器与电机型号适配 The KRS series drive and motor model adaptation

电机型号 Motor model	Pn001	额定转速 Rated speed (r/min)	额定转矩 Rated torque (N. M)	额定功率 Rated power (W)	KRS 15A	KRS 20A	KRS 30A	KRS 50A	KRS 75A
60st_m00630	0	3000	0.6	200	✓	✓	✓		
60st_m01330	1	3000	1.3	400	✓	✓	✓		
60st_m01930	2	3000	1.9	600	✓	✓	✓		
80st_m01330	3	3000	1.3	400	✓	✓	✓		
80st_m02430	4	3000	2.4	750	✓	✓	✓		
80st_m03520	5	2000	3.5	730	✓	✓	✓		
80st_m04025	6	2500	4	1000	✓	✓	✓		
90st_m02430	7	3000	2.4	750	✓	✓	✓		
90st_m03520	8	2000	3.5	730	✓	✓	✓		
90st_m04025	9	2500	4	1000	✓	✓	✓		
110st_m02030	10	3000	2	600	✓	✓	✓		
110st_m04020	11	2000	4	800	✓	✓	✓		
110st_m04030	12	3000	4	1200		✓	✓		
110st_m05030	13	3000	5	1500			✓		
110st_m06020	14	2000	6	1200	✓	✓	✓		
110st_m06030	15	3000	6	1800			✓		
130st_m04025	16	2500	4	1000	✓	✓	✓		
130st_m06015	17	1500	6	1000	✓	✓	✓		
130st_m05025	18	2500	5	1300		✓	✓		
130st_m06025	19	2500	6	1500			✓		
130st_m07725	20	2500	7.7	2000			✓		
130st_m10010	21	1000	10	1000	✓	✓	✓		
130st_m10015	22	1500	10	1500		✓	✓		
130st_m10025	23	2500	10	2600			✓	✓	✓
130st_m15015	24	1500	15	2300			✓		
130st_m15025	25	2500	15	3800				✓	✓
150st_m15025	26	2500	15	3800				✓	✓
150st_m15020	27	2000	15	3000				✓	✓
150st_m18020	28	2000	18	3600				✓	✓

150st_m23020	29	2000	23	4700				√	√
150st_m27020	30	2000	27	5500					√
180st_m17215	31	1500	17.2	2700				√	√
180st_m19015	32	1500	19	3000				√	√
180st_m21520	33	2000	21.5	4500				√	√
180st_m27010	34	1000	27	2900				√	√
220st_m67010	35	1000	67	1000					√

第二章 接线 Chapter 2 wiring

2.1 系统组成与接线 The system composition and wiring

2.1.1 伺服驱动器接线图 Servo driver wiring diagram

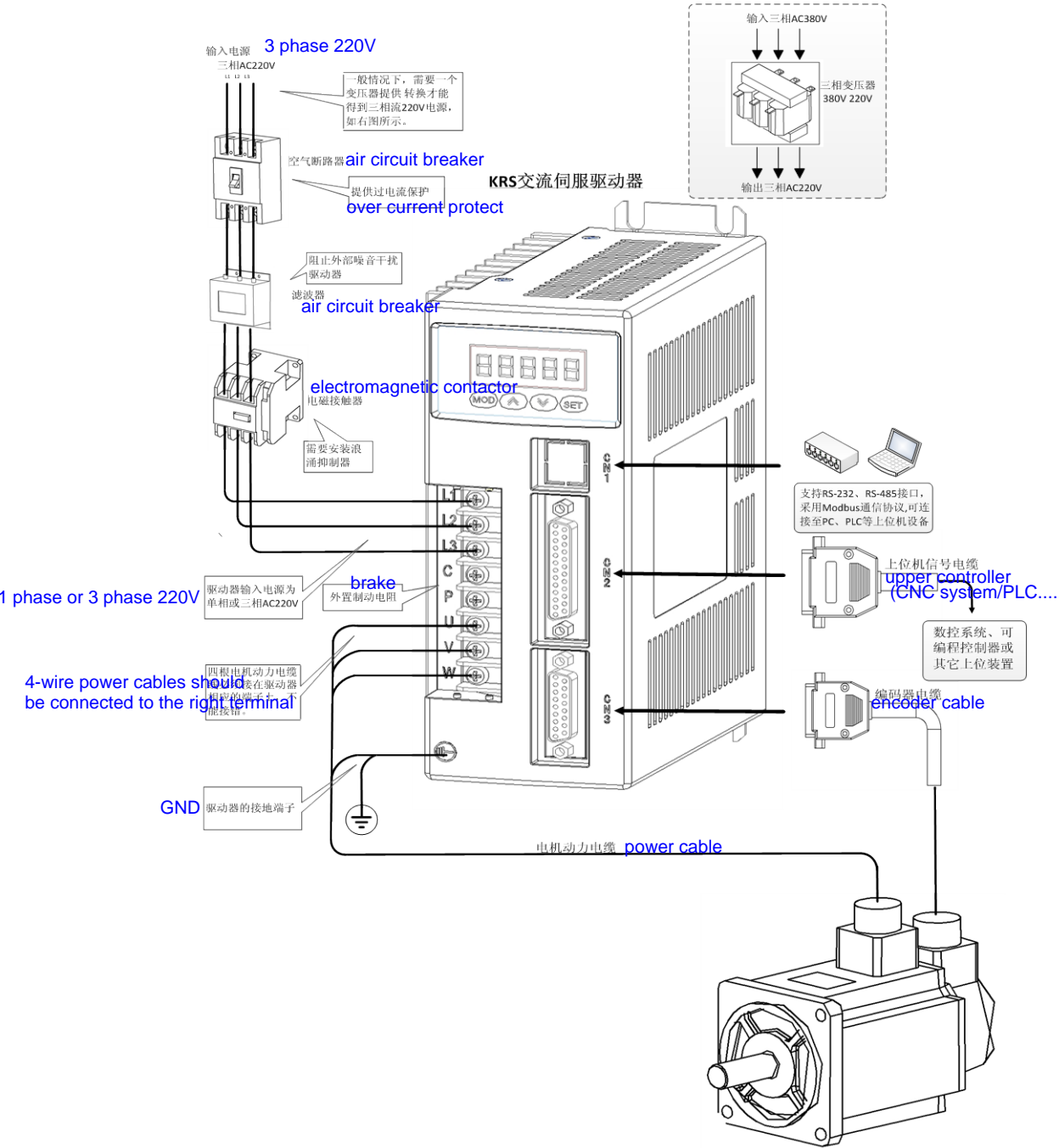

2.1.2 接线说明 Wiring instructions

接线注意事项: Wiring matters needing attention:

- 接线材料依照电线规格使用。The wire material should be in accordance with the wire specification.

- 电缆长度, 指令电缆 3m 以内, 编码器电缆 20m 以内。Cable length, instruction cable within 3 m, encoder cable within 20 m
- 检查 L1、L2、L3 电源接线是否正确, 请勿接到 380V 电源上。Check the L1, L2, L3 power wiring is correct or not, please do not connect to the 380 v power supply.
- 电机输出 U、V、W 端子相序, 必须和电机相应端子一一对应, 接错电机可能不转或飞车。不能用调换三相端子的方法来使电机反转, 这一点与异步电机完全不同。U, V, W terminal phase sequence, must be corresponded to the terminal correspondence of the motor, **otherwise, the motor** may not transfer or coaster, the motor may not transfer or coaster. Can't use exchange three-phase terminal method to make motor reversal, this is totally different with asynchronous motor
- 必须可靠接地, 而且单点接地。must be reliable grounding, and single point grounding
- 装在输出信号的继电器, 其吸收用的二极管的方向要连接正确, 否则会造成故障无法输出信号。into the output signal of the relay, the absorption of the direction of the diode to connected correctly, otherwise it will cause failure cannot output signal
- 为了防止噪声造成的错误动作, 请在电源上加入绝缘变压器及噪声滤波器等装置在同一配线管内。in order to prevent noise caused by the wrong action, please add in power transformer and noise filter device in the same wiring tube
- 请安装非熔断型断路器使驱动器故障能及时切断外部电源。please install the fuse type circuit breaker that drive failure can promptly cut off the external power supply

2.1.3 电线规格 Wire specifications

连接端子 terminals	符号	电线规格 wire specifications
电源线 Power cord	U、V、	0.75~2.5mm ²
电机连接端子 Motor terminals		0.75~2.5mm ²
接地端子 Earthing terminal terminal		0.75~2.5mm ²
控制信号端子 control symbol	C N 2	≥0.12 mm ² (AWG26), 含屏蔽线 Including shielded
编码器信号端子 Encoder signal	C N 3	≥0.12 mm ² (AWG26), 含屏蔽线 Including shielded

编码器电缆必须使用双绞线。如果编码器电缆太长 (>20m), 会导致编码器供电不足, 其电源和地线可采用多线连接或使用粗电线。Encoder cable must use twisted-pair cable. If the encoder cable is

too long (> twenty m), can lead to encoder power supply shortage, its power source and ground can use multiple wire connection or use thick wire

2.1.4 强电端子说明

名称 name	端子符号 Terminal symbol	详细说明 Detailed description
主电路电源 Main circuit power	L1、L2、L3	连接外部交流电源 三相 220VAC -15%~+10% 50/60Hz Connect the external ac power three-phase 220VAC -15%~+10% 50/60Hz
电机连接端子 Motor terminals	U	输出到电机 U 相电源 The output to motor U phase power
	V	输出到电机 V 相电源 The output to motor V phase power
	W	输出到电机 W 相电源 The output to motor W phase power
接地端子 Earthing terminal		电机外壳接地端子 Motor shell earthing terminal
		驱动器接地端子 Drive earthing terminal

2.2 CN1 通信接口 Communication interface

2.2.1 CN1 端口编号 Port Numbers

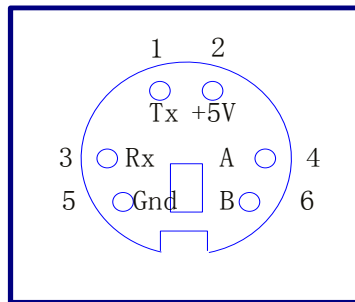

2.2.2 CN1 端口说明 CN1 port

引脚 pin	编号 number
+5V	2
GND	5
RS-232 发送引脚 Tx Send pin Tx	1
RS-232 接收引脚 Rx Receiving pin RX	3
RS-485 A	4

2.2.3 CN1 端口类型 port type

1. RS-232 接口 interface

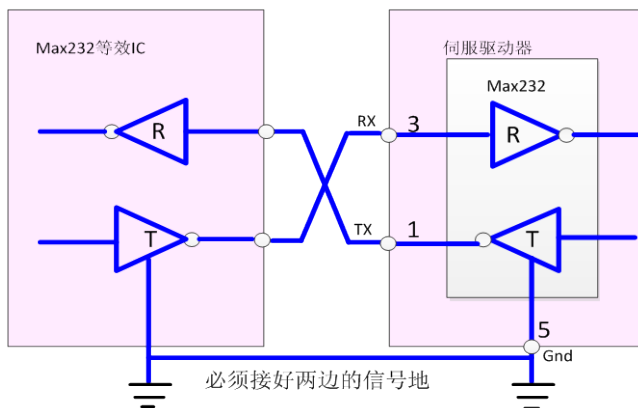

2. RS-485 接口 interface

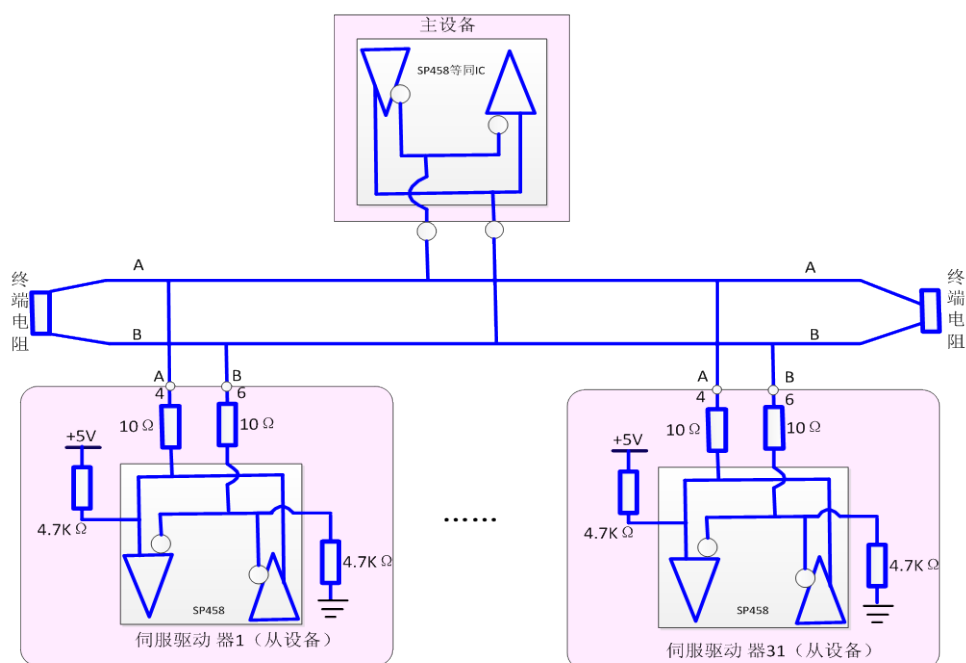

●采用 RS485 通信时，最多可同时连接 31 台伺服驱动器，485 网络末端需分别接一个 120 欧电阻的终端电阻。若欲连接更多的设备，必须用中继器来扩展连接的台数。Adopt RS485 communication, at the same time the most connected and table servo drive, 485 network terminals separately by one euro 120 resistance terminal resistances. If want to connect more equipment, must use Repeaters to expand the connection Numbers

2.3 CN2 控制接口 Control interface

CN2 控制信号端子提供与上位控制器边接所需要的信号，使用 DB25 插座，信号包括：CN2 control signal terminal to provide and the upper controller connection need signal, use DB25 socket, signs include:

- 4 个可编程输入； Four programmable input
- 4 个可编程输出； Four programmable output
- 模拟量指令输入； Analog quantity order input
- 脉冲指令输入； Pulse command input
- 编码器信号输入。 Encoder signal input

2.3.1 CN2 端口编号 port numbers

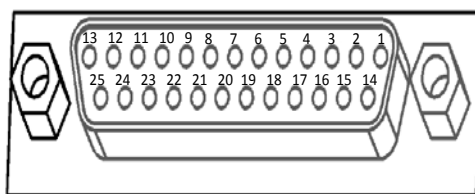

2.3.2 CN2 端口说明 CN2 port instructions

引脚 pin	接口编号 interface number	名称 name	功能 function
DC12~24V COM	9 10	控制信号的电源与地 The control signal of power supply and ground	输入输出控制信号的输入电源和地 Input/output control signal input power and ground
SigIn1 SigIn2 SigIn3 SigIn4	6 7 21 8	输入指令信号 Input command signal	输入指令信号。出厂时各个输入信号端口 指定的功能：Input command signal. The factory all input signal port specified functions: SigIn1:伺服使能 SRV-ON SigIn2:报警复位 alarm reset SigIn3:位置偏差清零 Zero position

			deviation SigIn4:零速箝位 Zero speed clamp
SigOUT1 SigOUT2 SigOUT3 SigOUT4	11 23 12 24	输出指令信号 output command signal	输出指令信号。出厂时各个输出信号端口指定的功能: output command signal. The factory all output signal port specified functions: SigOUT1: 伺服准备好 Servo ready SigOUT2: 报警检出 Alarm detection SigOUT3: 定位完成 Positioningcomplete SigOUT4: 零速 Zero speed
PV PP+ PP- PD+ PD-	2 3 14 4 5	指令脉冲输入端口 Instruction pulse input port	PV:集电极开路输入电源 PV:open collector input power 指令脉冲可以三种不同方式输入: Instruction pulse can be three different ways to input 1: 指令方向和脉冲输入 Instruction direction and pulse input 2: 顺时针/逆时针脉冲输入 Clockwise or counterclockwise pulse input 3: 相位差 90 度的正交输入 Phase difference 90 degrees of orthogonal input
PA+ PA- PB+ PB- PZ+ PZ- OZ GND	20 19 18 17 15 16 22 1	编码器信号输出 Encoder signal output	编码器信号 (ABZ) 的输出端口。通过参数设定, AB 信号可分频输出和逻辑取反输出。Encoder signal (ABZ) output port. Through the parameter setting, AB signal separable frequency output and logic take back output.
Vref AGND	25 13	模拟量输入 Analog input	模拟电压输入端口。速度或力矩控制时, 用于接收速度或力矩指令。电压输入范围 -10V~+10V。 Analog voltage input port. The speed or torque control, used for receiving the speed or torque command. Voltage input range-10V~+10V。

2.2.3 CN2 端口类型 Port type

1. 数字输入接口 Digital input interface

数字输入接口电路可由开关、继电器、集电极开路三极管、光电耦合器等进行控制。继电器需选择低电流继电器,以避免接触不良的现象。外部电压范围 DC12V~24V。Digital input interface circuit by switch, relay, open collector triode, photoelectric coupler of control. Relay required to choose low current relay, in order to avoid the phenomenon of poor contact. External voltage range DC12V ~ 24 V.

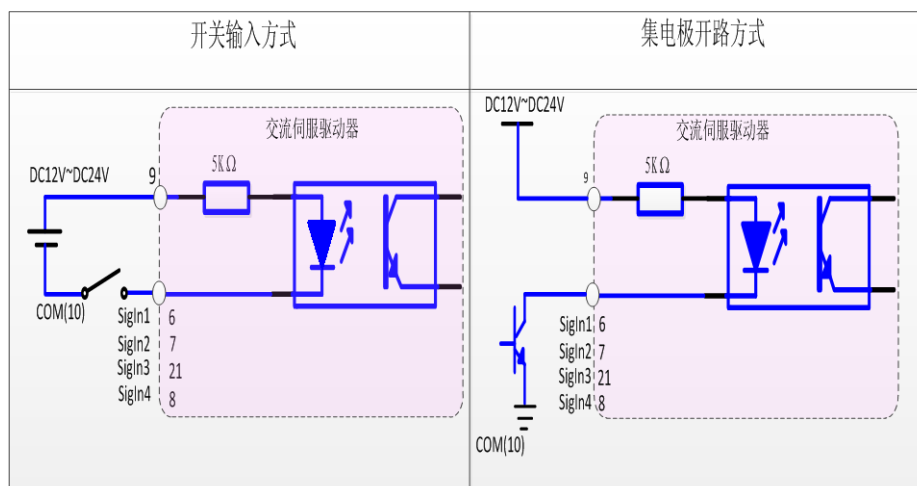

2. 数字输出接口 Digital output interface

输出电路采用达林顿光电耦合器,可与继电器、光电耦合器连接。Output circuit adopts darlington photoelectric coupler, but with relay, photoelectric coupler

注意事项: Note:

●外部电源由用户提供,但是必须注意,如果电源的极性接反,可能导致伺服驱动器损坏。

External power supply by users, but must pay attention to, if the power polarity meet back, may cause damage to the servo driver.

●输出为集电极开路形式,最大电流 70mA,外部电源最大电压 25V。如果超过限定要求或输出直接与电源连接,可能导致伺服驱动器损坏。

When the output open collector form, the maximum current is 70 mA, the external power peak voltage is 25 V. If more than limit requirements or output directly with power connection, may cause damage to the servo driver.

●如果负载是继电器等感性负载，必须在负载两端反并联续流二极管。如果续流二极管接反，可能导致伺服驱动器损坏。

If the load is relay and inductive load, the load must be both ends against parallel fly-wheel diode. If fly-wheel diode picks back, may cause damage to the servo driver.

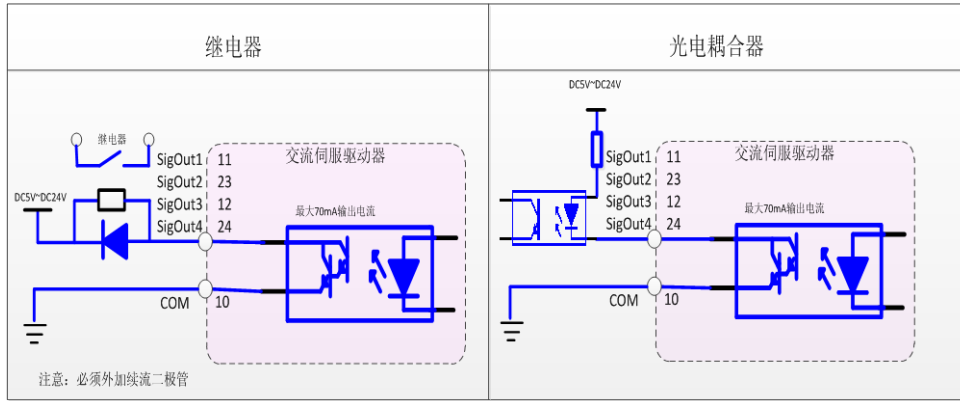

3. 位置脉冲指令接口 Position pulse command interface

有差分驱动和单端驱动两种接法，推荐差分驱动接法。接线宜采用双绞线。A differential drive and single end drive have two connections, recommend differential drive connection. Connection appropriate USES twisted-pair cable

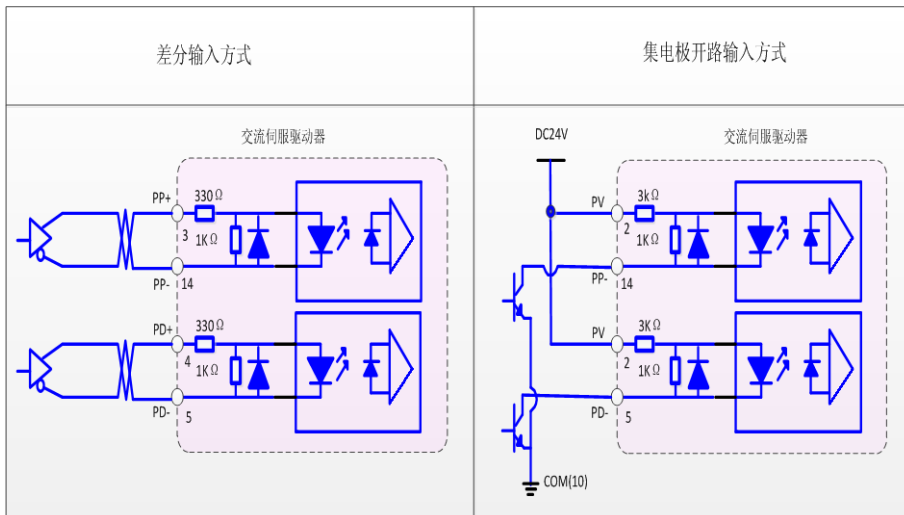

●在差分输入方式下，建议采用 AM26LS31 类似线驱动器；为了使传送的脉冲数据有很好的抗干扰能力，建议采用差分驱动方式；最大输入脉冲频率 500kHz(kpps) 。In the differential input mode, it is recommended AM26LS31 similar line drive; In order to make the transfer of pulse data has good anti-interference ability, it is suggested that the differential drive way; Maximum input pulse frequency 500 KHZ (KPPS).

●在采用集电极开路输入方式下，最大输入脉冲频 200kHz(kpps) 。 In the open collector input mode, the maximum input pulse frequency 200 KHZ (KPPS)

4. 编码器信号线驱动输出 Encoder signal wire drive output

将编码器信号分频后通过线驱动器(26LS31)输出到上位控制器。The encoder signal frequency division through line drive (26 ls31) output to the upper controller

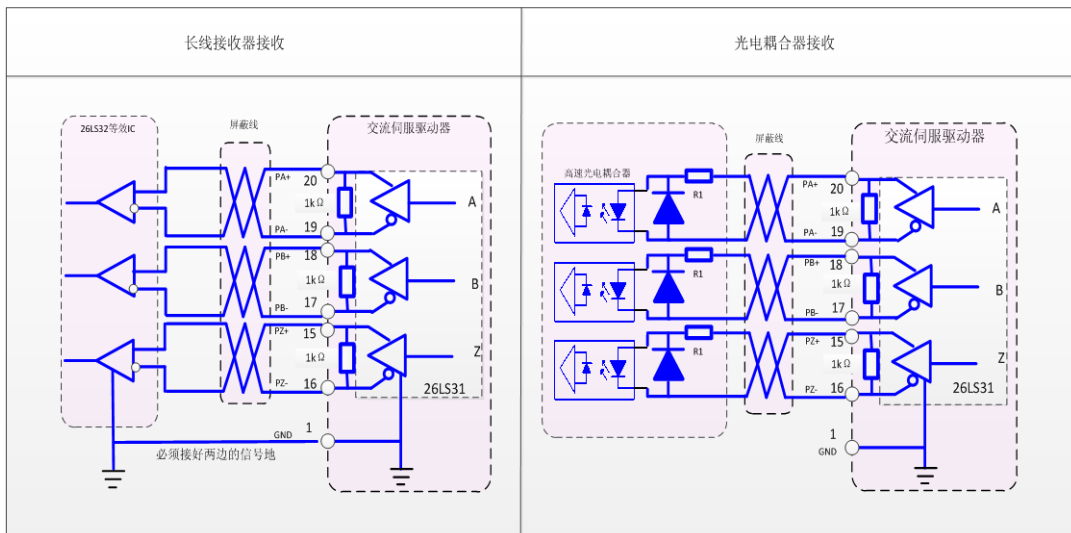

●在长线接收器接收时，驱动器编码器信号地(GND)必须和上位控制器信号地连接。 In the long term receiver receive, the drive encoder signal (GND) must and upper controller signal ground connection.

●在光电耦合器接收时，上位控制器使用高速光电耦合器(例如6N137)，限流电阻R1的值220Ω左右。 In the photoelectric coupler receiving, upper controller using high-speed photoelectric coupler (such as 6 n137), current limiting resistor R1 value about 220 Ω.

5. 编码器 Z 信号集电极开路输出 Encoder Z signal open collector output

伺服驱动器以集电极开路方式输出编码器的 Z 信号。由于 Z 信号脉宽较窄，上位机请使用高速光电耦合器接收。 Servo drives to open collector mode on the output signal of the encoder Z. Because Z letter feel the pulse

width is narrower, PC please use high-speed photoelectric coupler receiving

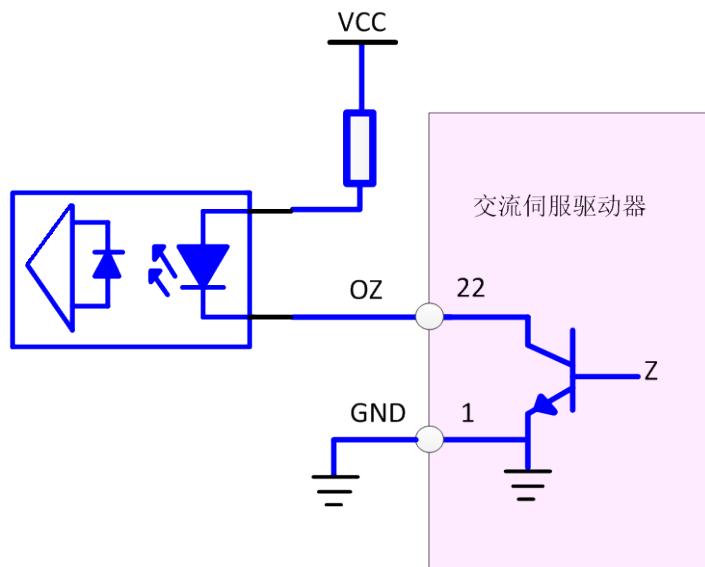

● VCC 最大电压 30V，输出电流最大 50mA。VCC peak voltage 30 V, output current maximum 50mA

2.4 CN3 编码器接口 CN3 Encoder interface

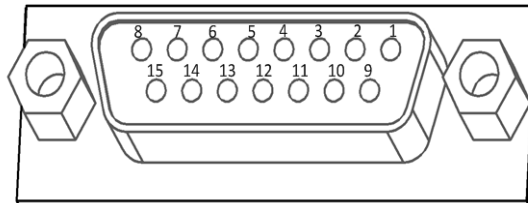

将伺服电机的编码器信号接到伺服驱动器的 CN3 上。Connect the servo motor encoder signal to CN3 of the servo driver.

引脚 pin	CN3 编号 number
+5v	8
GND	15
A+	3
A-	11
B+	10
B-	2
Z+	1

Z-	9
U+	6
U-	7
V+	5
V-	13
W+	12
W-	4
PE	14

2.3 标准接线 Standard connection

2.3.1 位置控制接线图 Position control wiring diagram

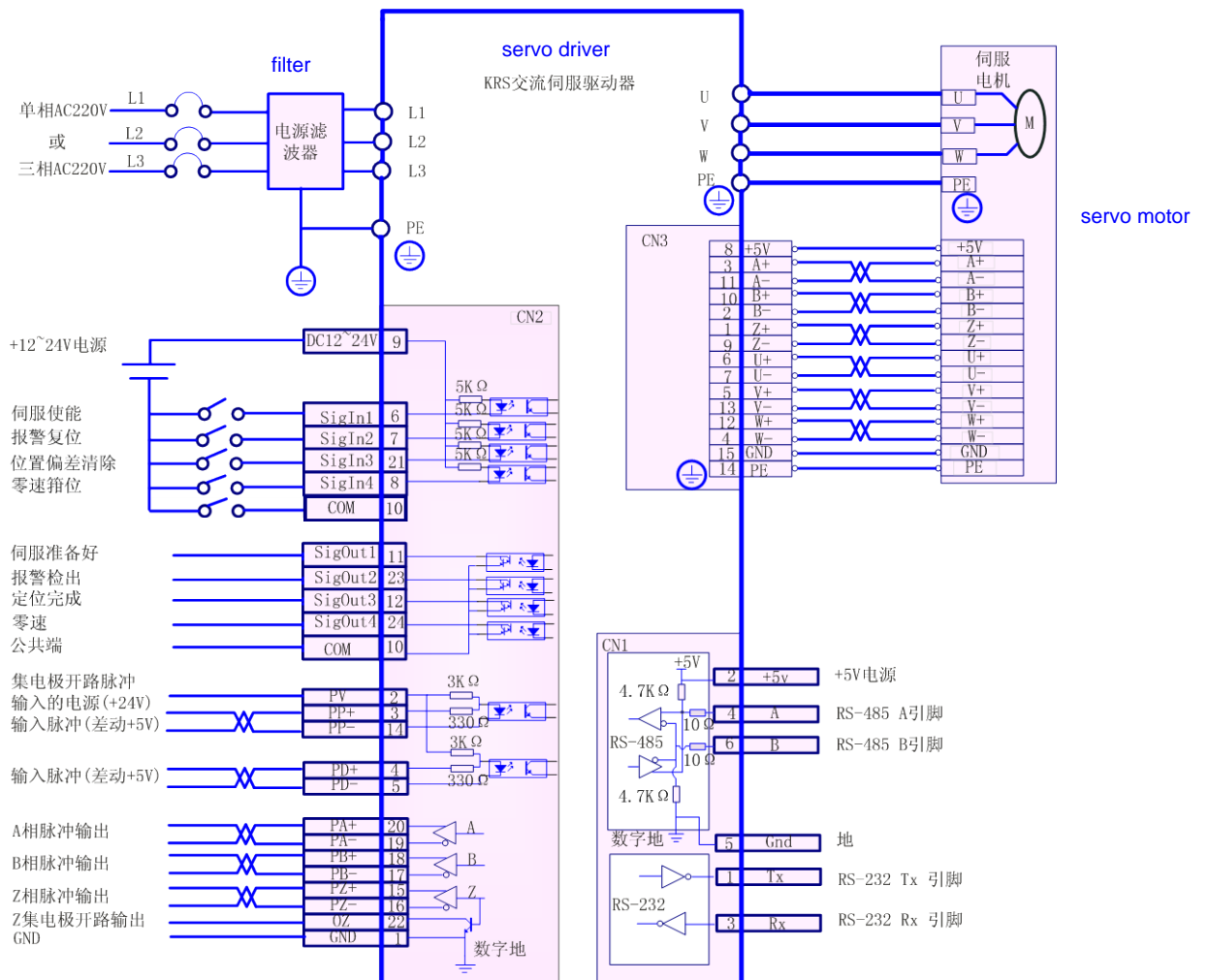

2.3.2 速度/转矩控制接线图 Speed, torque control wiring diagram

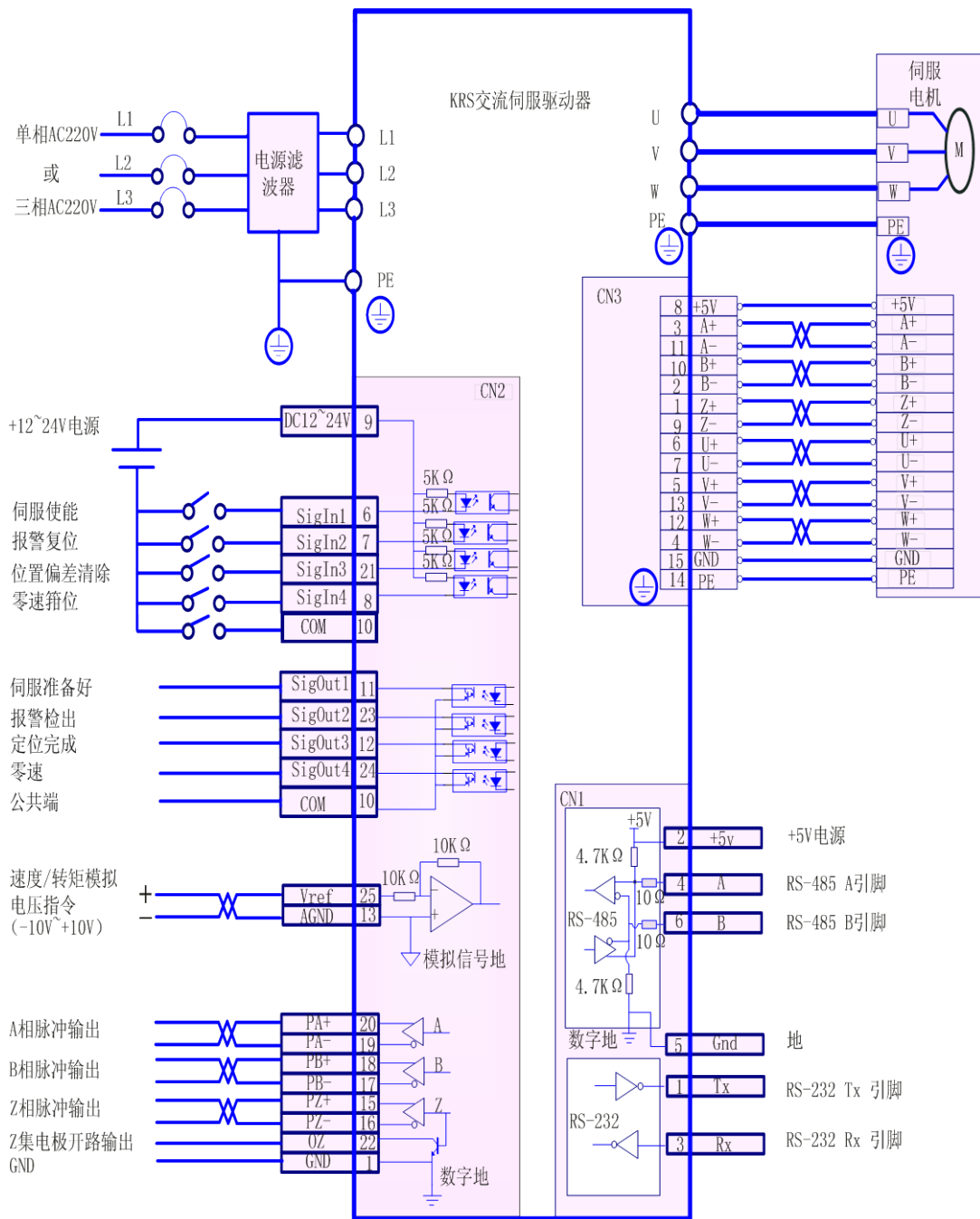

第三章 面板操作 Chapter 3 Panel operation

3.1 面板组成 panel

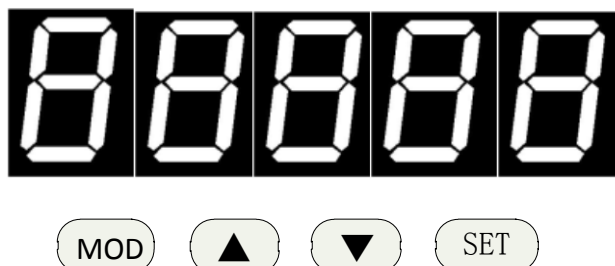

面板说明: panel instruction:

按键 key	按键名称 key name	功能 function
MODE	模式选择键 Mode option key	1 模式切换 mode switch 2 返回上级目录 Return to the superior directory
▲	数字增加键 Digital increase key	增加数字, 长按具有重复效果 increase number,long press has the effect of repeat
▼	数字减小键 Digital reduce key	减小数字, 长按具有重复效果 reduce number,long press has the effect of repeat
SET	移位确定键	1 数字移位 Digital shift 2 确定设定(需长按 1 秒钟)Determine the set (long by 1 second) 3 结束参数设定(需长按 1 秒钟) End set parameters (long by 1 second)

注意: 若显示屏 5 位小数点全部在闪烁, 警示有报警产生。必须清除报警后, 驱动器才能正常工作。Note: if the five decimal points of the display are flashing, there are some alarm.Must clear the alarm,the drive can work normally.

3.2 模式切换 mode switch

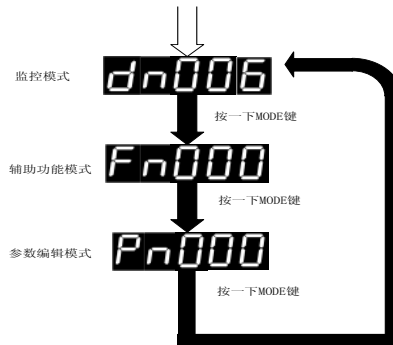

说明：当显示屏显示 Fnxxx,Dnxxx,Pnxxx 时,此时 mode 键为模式切换功能，可直接向其它模式切换，否则 mode 键为返回上层目录功能。Note: when the screen shows Fnxxx, Dnxxx, Pnxxx, mode key at this time as the mode switching function, can be to switched to other mode directly, otherwise the mode key is as the function of returning to the upper directory.

3.3 监控模式操作 Monitoring mode operation

例：查看dn015号监控参数,此时sigOut1端口 为低电平， sigOut2, sigOut3, sigOut4 端口为高电平。
Example: see dn015 monitoring parameters, sigOut1 port at this time as the low level, sigOut2, sigOut3, sigOut4 port are the high levels

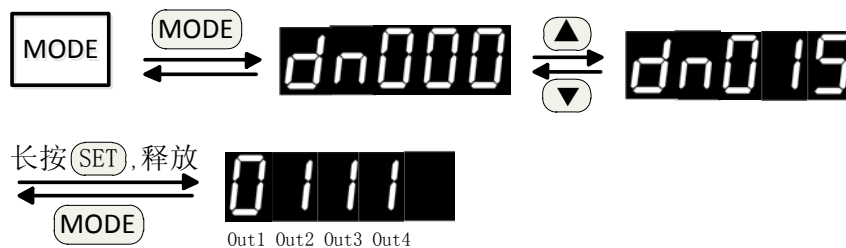

3.4 辅助模式操作 Auxiliary mode operation



辅助模式 功能编号

Auxiliary mode function number

3.4.1 辅助功能一览表 Auxiliary function list

编号 number	说明 instruction
Fn000	报警记录查询 Alarm record inquires
Fn001	用户参数永久写入。若用户对 Pn000~Pn219 中的参数进行了设置, 为下次上电后, 驱动器载入用户修改的参数, 必须执行本操作, 将参数写入内部 EEPROM 芯片。执行操作后, 需要 3 秒左右时间, 将所有参数写入 EEPROM 中。Permanently written to the user parameters. If users set the parameters of Pn000 ~ Pn219, For the next after power on, the drive is loaded the modify parameters by the user, you must perform this operation, the parameter block write internal EEPROM chip. After executing, need about 3 seconds, the block to write all the parameters into the EEPROM
Fn002	JOG 试运行操作 JOG Trial operation
Fn003	对当前检出的报警进行清除 clear the current detection alarm
Fn004	将参数表中的 Pn000~Pn219 的参数, 根据 Pn000 的设置情况, 恢复为出厂默认值。 The parameters of the parameter in the table Pn000 ~ Pn219, according to the setting of Pn000, restore to factory default
Fn005	位置偏差清零 Zero position deviation
Fn006	SigOut 端口强制输出, 强制状态仅限于此操作下有效。SigOut port output force, effectively under the forced state is limited to this operation 0: SigOut 所有端口取消强制状态。SigOut all ports to cancel compulsory state 1: SigOut 所有端口强制输出高电平。SigOut all ports output high level 2: SigOut 所有端口强制输出低电平。SigOut all ports output low level
Fn007	模拟转矩指令电压校正 Simulation of torque command voltage correction
Fn008	模拟速度指令电压校正 Simulation speed reference voltage correction
Fn009	母线电压校正 Busbar voltage correction
Fn010	温度校正 temperature calibration
Fn011	报警记录初始化 Initialization alarm record
Fn012	编码器调零 encoder zero

3.4.2 Fn000 报警功能查询 Alarm function query



3.4.3 Fn001 用户参数永久写入 Permanently written to the user parameters

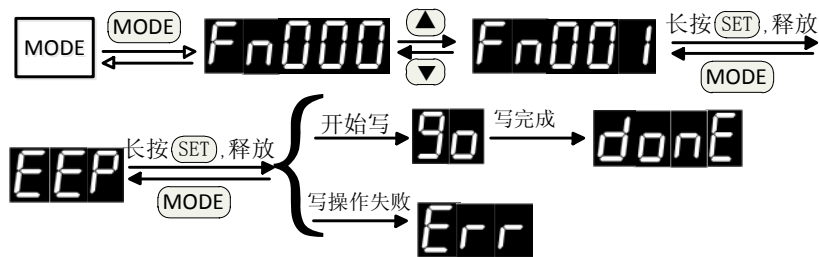

说明 1: 若最后操作显示 **Err**, 可能是驱动器内部正在执行写数据操作, 请等待几秒钟再尝试。

Instructions 1: if the last operation shows **Err**, may be internal drive is writing data operations performed, please wait a few seconds and try again

说明 2: 必须等待写完成再断电, 否则重新开机后, 可能导致存储芯片内容破坏 (AL-01 报警)。

2: Power outages after write completint, otherwise may cause memory chip content damage (AL - 01 alarm) after the reboot,

3.4.4 Fn002 试运行操作 Trial operation

0: 点动模式 Inching mode

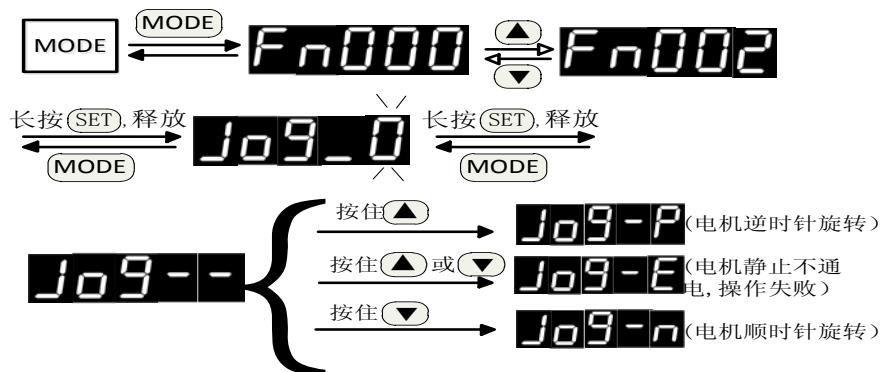

Jog 运行速度与加减速时间可由以下参数设定: JOG The speed and deceleration time is set by the following parameters

Pn177	JOG 速度 speed	0~5000	200	r/min
Pn178	JOG 加速时间 speed time	5~ 10000	100	ms
Pn179	JOG 减速时间 deceleration time	5~ 10000	100	ms

1: 进入调速模式 Into speed control mode

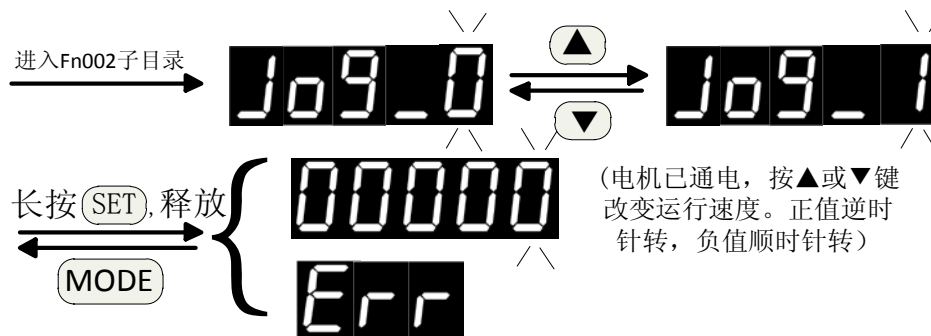

2: 退出调速模式 Exit speed control mode

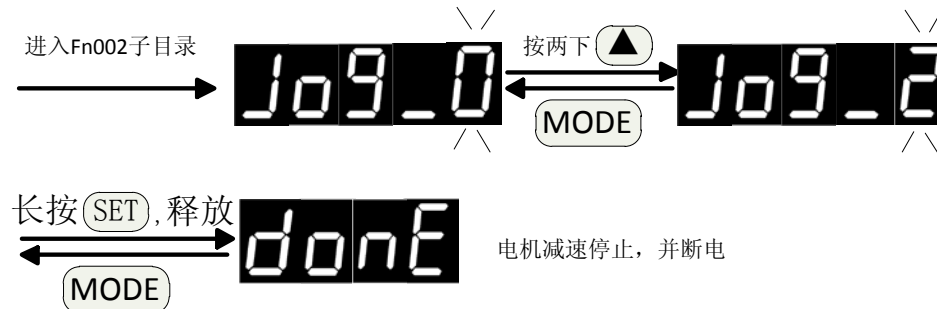

运行模式 operation mode	说明 instruction
0	点动模式。按住▲或▼键, 电机将进行顺时针或逆时针旋转; 释放▲或▼键, 电机将停止旋转, 处于不通电状态。Inching mode. Press ▲ or ▼ button, the motor will be clockwise or counterclockwise rotation; release ▲ or ▼ button, the motor will cease to spin, in a state of no electricity
1	进入调速模式,电机通电工作。驱动器处于速度环模式, 运行速度由按

	键▲或▼输入。在电机运行过程中，可进行其它的菜单操作。若使电机停止旋转，请进入 Jog_2 模式。Electricity into speed control mode, the motor. Drive at a speed loop model, running speed by buttons▲ or ▼ input. In the process of the motor running, the other menu operations can be performed. If the motor stop rotating, please enter Jog_2 mode
2	退出调速模式，电机断电。Exit speed control mode, the motor is power off

说明：若操作显示 **Jog-E** 或 **Err**，其可能的原因有：Note: if the display **Jog-E** or **Err** , the possible reasons are as follows:

1：电机已处于使能或旋转状态。在 JOG 试运行操作前，电机须处于非工作状态。建议试运行前，伺服驱动器控制接口不接任何控制线。The motor is in the state of enabling or rotating. JOG trial run before operation, the motor must be in a non-working state. when commissioning, the control interface of the servo drive don't be connected to any control lines.

2：伺服驱动器发生过报警，且报警未清除。Servo driver alarm has occurred, and the alarm is not cleared.

3.4.5 Fn003 报警清除操作 Alarm clearance operations

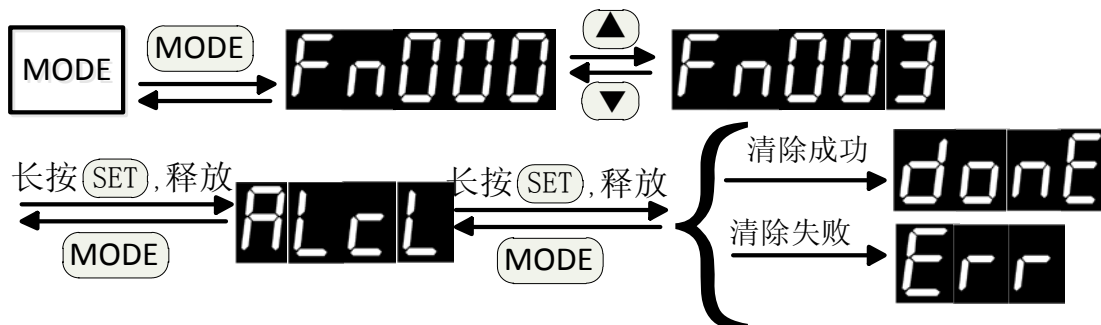

说明：当最后清除失败，显示 **Err**，则检出的报警只有再上电后方可清除。Note: When the clearance is failure at last, display **Err**, the Checked out alarm can be cleared only after power on again

通过清除操作可清除的报警 Through the clear operation to clear the alarm		再上电才可以清除的报警 Electricity can remove alarm again	
AL--02	低电压 Low voltage	AL--01	存储器异常 Storage anomaly
AL--05	过载 1 Overload 1	AL--03	过电压 overvoltage

AL--07	电机转速过高 Motor speed is too high	AL--04	智能功率模块异常 Intelligent power module is abnormal
AL--08	散热片过热 Heat sink is overheating	AL--06	过载2 Overload 2
AL--10	脉冲频率过高 Pulse frequency is too high	AL--09	编码器异常 The encoder abnormal
AL--11	位置脉冲偏差量过大 Pulse position deviation value is too large	AL--13	CPU 内部故障 The CPU internal fault
AL--12	电流采样回路可能损坏 Current sampling circuit may be damaged	AL--17	编码器信号分频输出设置异常The encoder signal frequency division output Settings abnormal
AL--14	紧急停机Emergency stop	AL--18	电机代码设置不当impeoper motor code setting abnormal
AL--15	驱动禁止异常 driving ban Abnormal		
AL--16	制动平均功率过载 Brake average power overload		

3.4.6 Fn004 参数初始化操作 Initialization parameters

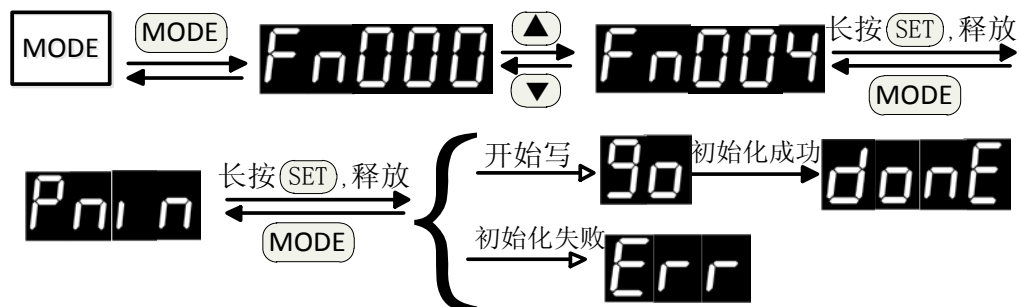

说明 1: 若最后操作显示 **Err**, 其可能的原因: Instructions 1: if the last operation display **Err**, the possible reason as following:

- 1: 驱动器正在执行写操作。Drives are executing write operations
- 2: 参数 Pn000 没有开放参数初始化功能。Parameters Pn000 doesn't open the parameters initialization function

说明 2: 必须等待写完成再断电, 否则重新开机后, 可能导致存储芯片内容破坏 (AL-01 报警)。

Instructions 2: must turn off the power after completing the wirting, otherwise ,after the reboot, may cause memory chip content damage (AL - 01 alarm)

3.4.7 Fn005 位置偏差清零操作 Clear operation position deviation

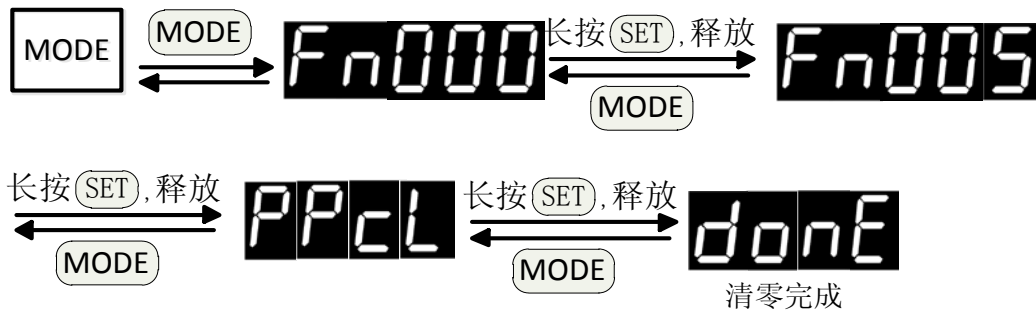

3.4.8 Fn006 端口强制输出 The output port is mandatory

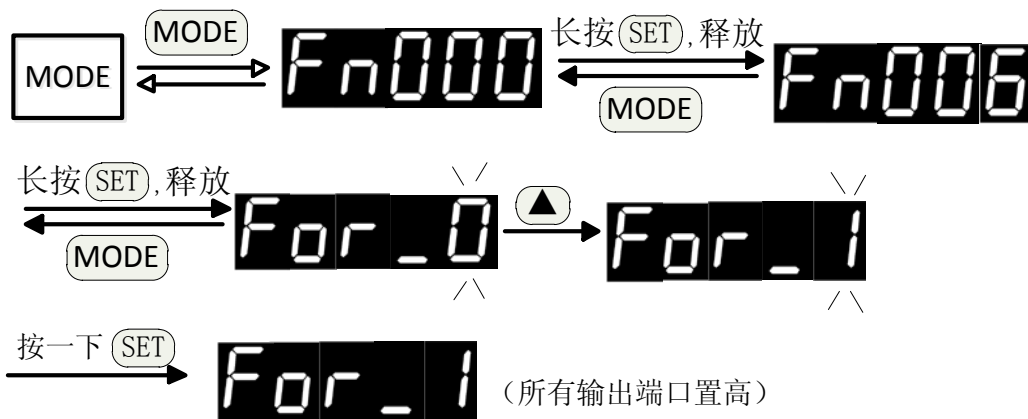

参数选择 Parameter selection	说明 instructions
0	取消强制状态 Cancel the forced state
1	所有 SigOut 端口强制置高 all sigoutall ports are forced high
2	所有 SigOut 端口强制置低 all sigoutall ports are forced low

3.4.9 Fn007 模拟转矩指令电压校正 Simulation of torque command voltage correction

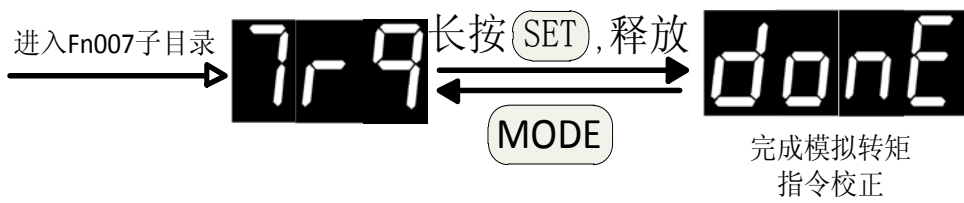

注 1: 在进行校正操作前, 先将 CN2 的模拟电压输入端口 Vref (25 脚) 与 AGND (13 脚) 直接短路。Note 1: before correcting operation, first direct short the CN2 analog voltage input port Vref (25 feet) and AGND circuit (13 feet)

3.4.10 Fn008 模拟速指令电压校正 Simulation speed command voltage correction

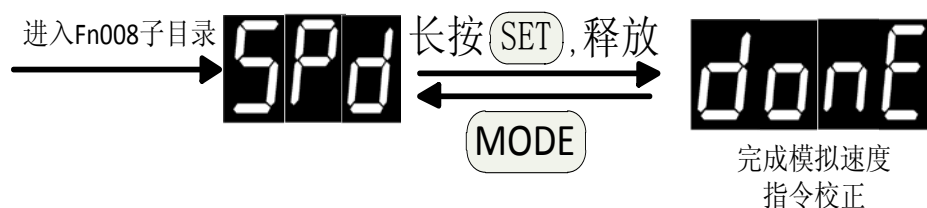

注 1: 在进行校正操作前, 先将 CN2 的模拟电压输入端口 Vref (25 脚) 与 AGND (13 脚) 直接短路。Note 1: before correcting operation, first direct short the CN2 analog voltage input port Vref (25 feet) and AGND circuit (13 feet)

3.4.11 Fn009 母线电压校正 Busbar voltage correction

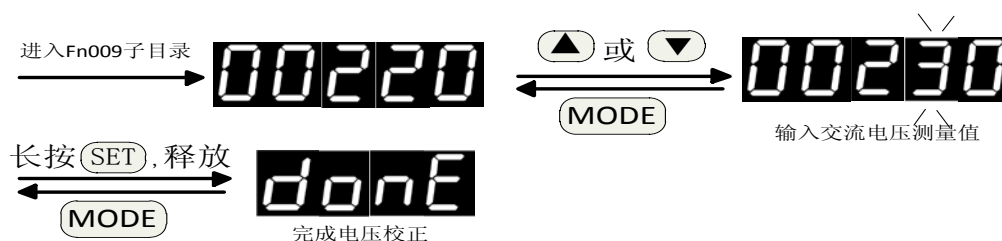

注 1: 在进行校正时, 测量驱动器输入的交流电压, 输入至本操作中。Note 1: when making correction, measurement drive input ac voltage, input to this operation.

3.4.12 Fn010 温度校正 The temperature calibration

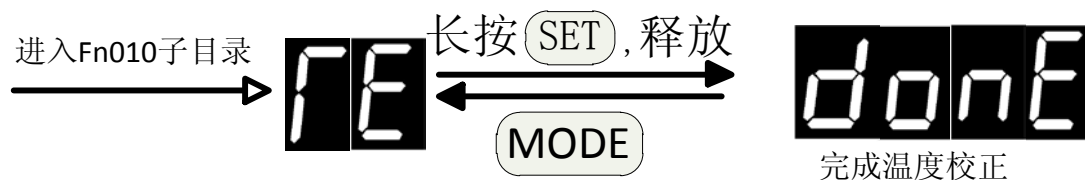

注 1: 进行本操作前, 先用 1.5K 高精度电阻替换温度传感器。Note 1: before the operation, the temperature sensor is replaced with 1.5 K high precision resistor.

3.4.13 Fn011 报警记录初始化操作 Alarm record initialization

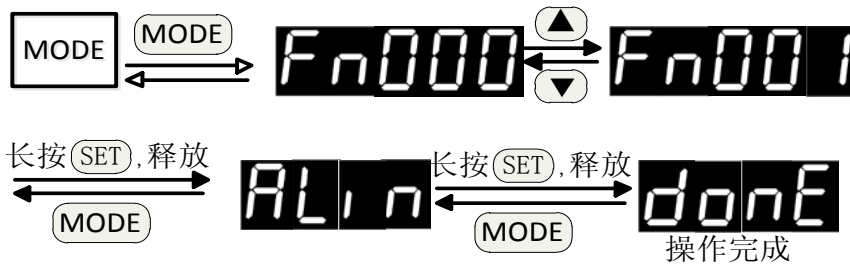

3.4.14 Fn012 编码器调零 The encoder zero

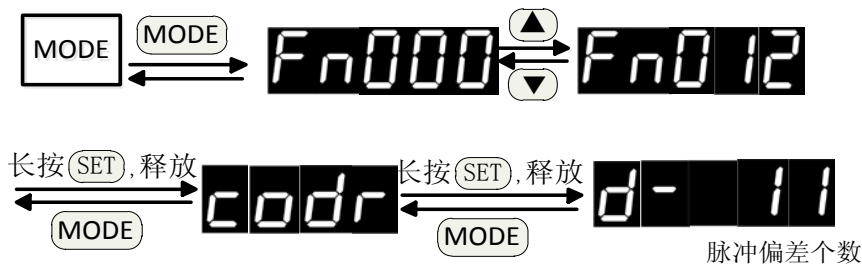

调零操作前，确认电机代码 Pn001 设置值与实际电机型号一致，否则可能导致电机电流过大，损坏电机。调零时，不需要内部使能或外部使能电机，电机将正转几圈，然后锁定零位。当显示的脉冲偏差个数为 0，此时电机已对准零位。Zero before operation, confirm the motor code Pn001 set value and the actual motor model is consistent, otherwise may lead to motor current is too large, damage the motor. Adjust zero, don't need can make internal or external can make the motor, the motor will turn a few laps, and then lock the zero. When the display number of pulse bias of 0, the motor has been aimed at zero.

注 1：若电机发热严重，须冷却一段时间。Note 1: if the motor heating, cooling for a period of time

3.5 用户参数模式操作 User parameter mode operation



参数模式 Parametric model

功能编号 function number

3.5.1 选择参数编号 Choose parameter number

例：选择 Pn011 参数。Example: select Pn011 parameters

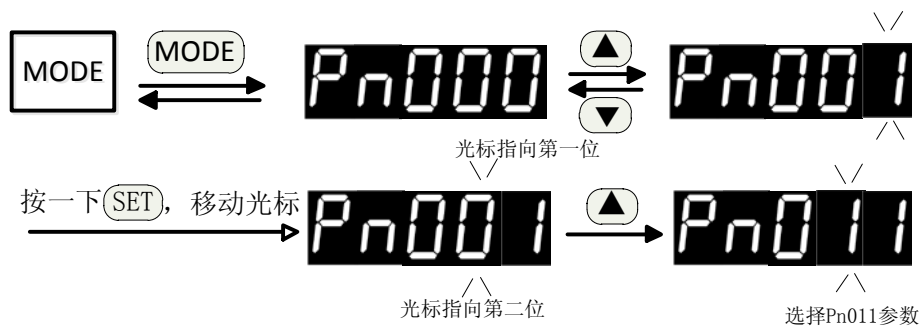

3.5.2 参数编辑 Edit parameters

例:把 Pn025 参数的当前值由 100 改成 200,具体操作如下: Example: change the current value of the Pn025 parameters from 100 to 200, the specific operation is as follows:

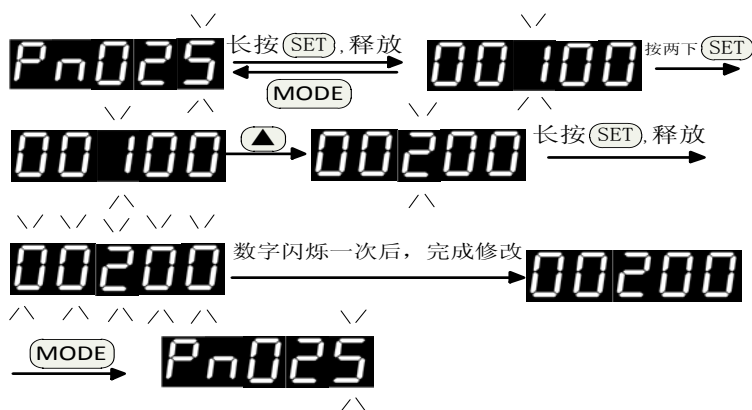

注:Pn025 参数修改后, 若没有进行保存操作 (Fn001 永久写入), 下次上电后, Pn025 参数仍为 100。 Note: Pn025 parameters are modified, if it does not have to save operation (Fn001 immortalised), after the next to electricity, Pn025 parameters still for 100.

第四章 功能参数 Chapter 4 function parameters

4.1 参数设置面板操作 Parameter Settings panel operation

详见第三章的“[用户参数模式操作](#)”。 As shown in the third chapter of "user mode"

4.2 参数一览表 Parameter list

- 编号一栏中，若有符号▲，表示参数设置后，须重新上电，才能生效；若有符号◆，表示参数设置后，重新使能电机，参数才能生效；若没有特殊符号，表示立即生效。In the column of Numbers, if any symbols ▲, said after the parameter Settings, be it with electricity, can take effect; If symbol ◆, said after the parameter Settings, to enable motor, parameters take effect; If no special symbols, effective immediately
- 适用模式一栏中，All 表示适用于转矩、速度、位置控制，T 表示适用于转矩控制，S 表示适用于速度控制，P 表示适用于位置控制。The column of applicable mode, All said is suitable for the torque, speed and position control, T is suitable for the torque control, S suitable for speed control, said P is suitable for the position control.
- 必须谨慎设置参数。若设置不当，可能会导致电机运转不稳定。Must set parameters carefully. If setting undeserved, may cause the motor running is not stable

4.2.1 系统参数 System parameters

编号 number	名称 name	取值范围 Value range	默认值 The default value	单位 unit	适用 apply
Pn000	开放参数初始化功能 Open parameters initialization function	0~2	1		All
Pn001▲	电机代码 motor code	3-12	3		All
Pn002▲	控制模式 control mode	0~5	2		All
Pn003	伺服使能方式 Servo enabled	0~1	0		All
Pn004	伺服断使能停机方式 Servo broken that can stop	0~2	0		All
Pn005	断使能减速时间 Can make deceleration time	5-10000	100	ms	All
Pn006	使用/不使用正反驱动禁止 With/without positive driving is prohibited	0-3	0		All
Pn007	正/反驱动禁止停机减速时间 Is/ reverse the driver stop deceleration time is prohibited	0-10000	60	ms	All
Pn008	内部正转转矩限制(CCW) Internal around are torque limit (CCW)	0-300	300	%	All

Pn009	内部反转转矩限制 (CW) Around inside the torque limit (the CW)	-300~0	-300	%	All
Pn010	外部正转转矩限制(CCW) External around are torque limit (CCW)	0-300	300	%	All
Pn011	外部反转转矩限制(CW) Around outside the torque limit (the CW)	-300~0	-300	%	All
Pn012	正转 (CCW) 转矩过载 1 报警水平 Forward (CCW) torque overload alarm level 1	0-300	200	%	All
Pn013	反转 (CW) 转矩过载 1 报警水平 Inversion (the CW) torque overload alarm level 1	-300-0	-200	%	All
Pn014	转矩过载 1 报警检测时间 Torque overload alarm detection 1 time	0-800	80	100ms	All
Pn015	过载 2 检测时间 Overload 2 testing time	0-150	40	100ms	All
Pn016▲	编码器分频输出之分子 DA The molecular DA of encoder divider output	1~63	1		All
Pn017▲	编码器分频输出之分母 DB The denominator DB of encoder divider output	1~63	1		All
Pn018▲	编码器输出脉冲 AB 相位逻辑取反 Take the encoder output pulse AB phase logic	0-1	0		All
Pn019▲	额定电流设置 Rated current Settings	0-50	0	A	All
Pn020▲	额定转速设置 Rated speed setting	0~5000	0	r/min	All
Pn021	到达预定速度 reach the predetermined speed	0~5000	500	r/min	All
Pn022	到达预定速度迟滞比较差值 Hysteresis comparison difference in speed	0~5000	30	r/min	All
Pn023	到达预定速度检测方向 Reach the predetermined speed detection direction	0-2	0		All
Pn024	到达预定转矩 Reach the	0-300	100	%	All

	predetermined torque				
Pn025	到达预定转矩迟滞比较差值 Reach the predetermined torque hysteresis comparison difference	0-300	5	%	All
Pn026	到达预定转矩方向 Reach the predetermined torque direction	0-2	0		All
Pn027	零速检测幅度设定 Zero velocity detection range setting	0~1000	10	r/min	All
Pn028	零速检测回差 Zero speed test back to the poor	0~1000	5	r/min	All
Pn029	电机电磁制动零速检测点 Motor electromagnetic brake testing point zero speed	0~1000	5	r/min	All
Pn030	电机静止时电磁制动器延时时间 The motor stops electromagnetic brake delay time	0~2000	0	Ms	All
Pn031	电机运转时电磁制动器等待时间 The motor electromagnetic brake waiting time during operation	0~2000	500	ms	All
Pn032	电机运转时电磁制动器动作速度 The motor speed of electromagnetic brake action during operation	0-3000	30	r/min	All
Pn033	原点回归触发方式 The origin is triggered	0~3	0		All
Pn034	原点回归参考点模式 The origin return reference point model	0~5	0		All
Pn035	原点回归原点模式 The origin back to the origin model	0~2	0		All
Pn036	原点位置偏移高位 The origin position offset high	-9999~9999	0	万个脉冲	All
Pn037	原点位置偏移低位 The origin position offset low	-9999~9999	0	脉冲	All
Pn038	原点回归第一速度 The origin back to the first speed	1~3000	200	R/min	All
Pn039	原点回归第二速度 The origin back to the second speed	1~3000	50	R/min	All

Pn040	原点回归加速时间 The accelerating time of origin	5~10000	50	ms	All
Pn041	原点回归减速时间 The origin return to slow down time	5~10000	50	ms	All
Pn042	原点在位延时 The origin in the delay	0~3000	60	ms	All
Pn043	原点回归完成信号延时 Complete signal delay of origin	5~3000	80	ms	All
Pn044	原点回归指令执行模式 The origin of origin instruction execution mode	0~1	0		All
Pn045	增益切换选择 Gain switch to choose	0~5	5		All
Pn046	增益切换水平 Gain switch level	0~30000	80		All
Pn047	增益切换回差 Gain switch back to the poor	0~30000	6		All
Pn048	增益切换延迟时间 Gain switch delay time	0~20000	20	0.1ms	All
Pn049◆	增益切换时间 1 Gain switch time 1	0~15000	0	0.1ms	All
Pn050◆	增益切换时间 2 Gain switch time 2	0~15000	50	0.1ms	All
Pn051	电机运行最高速度限定 The motor running top speed limit	0~5000	3000		All
Pn052▲	SigIn1 端口功能分配 SigIn1 port functional allocation	-27~27	1		All
Pn053▲	SigIn 2 端口功能分配 SigIn 2 port functional allocation	-27~27	2		All
Pn054▲	SigIn 3 端口功能分配 SigIn 3 port functional allocation	-27~27	19		All
Pn055▲	SigIn 4 端口功能分配 SigIn 4 port functional allocation	-27~27	8		All
Pn056	SigIn 1 端口滤波时间 SigIn 1 port filtering time	1~1000	2	ms	All
Pn057	SigIn 2 端口滤波时间 SigIn 2 port filtering time	1~1000	2	ms	All
Pn058	SigIn 3 端口滤波时间 SigIn 3 port filtering time	1~1000	2	ms	All
Pn059	SigIn 4 端口滤波时间 SigIn 4 port filtering time	1~1000	2	ms	All
Pn060▲	SigOut1 端口功能分配 SigOut 1 port	-14~14	2		All

	functional allocation				
Pn061▲	SigOut 2 端口功能分配 SigOut 2 port functional allocation	-14~14	1		All
Pn062▲	SigOut 3 端口功能分配 SigOut 3 port functional allocation	-14~14	4		All
Pn063▲	SigOut 4 端口功能分配 SigOut 4 port functional allocation	-14~14	7		All
Pn064▲	通信方式 Communication mode	0-2	0		All
Pn065	通信站点 Communications site	1-254	1		All
Pn066▲	通信波特率 Communication baud rate	0-3	1		All
Pn067▲	通信模式设定 Communication mode setting	0-8	8		All
Pn068	输入功能控制方式选择寄存器 1 Input function control mode select register 1	0~32767	0		All
Pn069	输入功能控制方式选择寄存器 2 Input function control mode select register 2	0~4095	0		All
Pn070	输入功能逻辑状态设置寄存器 1 Input function logic state set register 1	0~32767	32691		All
Pn071	输入功能逻辑状态设置寄存器 2 Input function logic state set register 2	0~4095	4095		All
Pn072	内部使用 Internal use				
Pn073	内部使用 Internal use				
Pn074	风扇开启温度 Fan function temperature	30~70	50	摄氏 度	All
Pn075	风扇运行方式 Fan operation mode	0~2	0		All
Pn076	紧急停机(EMG)复位方式 Emergency stop reset (EMG)	0-1	0		All
Pn077	正/反驱动禁止检出 Positive and negative driving ban checked out	0-2	0		All
Pn078	电压不足检出 Lack of voltage detection	0~1	1		All
Pn079	系统状态显示项目选择 The system status display project selection	0-23	0		All
Pn080▲	编码器选择 The encoder to choose	0~0	0		All
Pn081	用户参数永久写入操作 User preferences permanent write	0-1	0		All

	operation				
Pn082	SigOut 端口强制输出 SigOut port force output	0	0~255		All
Pn083	低压报警检测幅值 Low pressure alarm detect amplitude	50~280	200	V	All
Pn084	高压报警检测幅值 High pressure alarm detect amplitude	290~380V	365	V	All
Pn085▲	电机极对数 Motor pole logarithmic	1~100	4	对	All
Pn086	再生电路放电周期 Renewable circuit discharge cycle	0~2000	70	ms	All
Pn087- pn095	内部使用 Internal use	-	-	-	-

4.2.2 位置控制参数 Position control parameters

编号 number	名称 name	取值范围 Value range	默认值 The default value	单位 unit	适用 apply
Pn096▲	指令脉冲输入方式 The command pulse input mode	0-2	0		P
Pn097▲	指令脉冲输入方向逻辑选择 Instruction selection logic pulse input direction	0-1	0		P
Pn098	脉冲电子齿轮比之分子 1 Pulse electronics gear than the molecules of 1	1~32767	1		P
Pn099	脉冲电子齿轮比之分子 2 Pulse electronics gear than the molecules of 2	1~32767	1		P
Pn100	脉冲电子齿轮比之分子 3 Pulse electronics gear than the molecules of 3	1~32767	1		P
Pn101	脉冲电子齿轮比之分子 4 Pulse electronics gear than the molecules of 4	1~32767	1		P
Pn102▲	脉冲电子齿轮比之分母 Pulse electronics gear than the	1~32767	1		P

	denominator				
Pn103	位置偏差超出范围设定 Beyond the scope of setting position deviation	1~ 500	500	千个脉冲 Thous and pulse	P
Pn104	位置定位完成范围设定 Complete range set position location	0~ 32767	10	脉冲 pulse	P
Pn105	位置定位完成回差设定 Positioning to complete set	0~ 32767	3	脉冲 pulse	P
Pn106	位置定位接近范围设定 Position location close to the range of Settings	0~ 32767	300	脉冲 pulse	P
Pn107	位置定位接近回差设定 Position location close to the poor set back	0~ 32767	30	脉冲 pulse	P
Pn108	位置偏差清除方式 Position deviation clear way	0-1	1		P
Pn109◆	位置指令加减速方式 Position command deceleration mode	0-2	1		P
Pn110◆	位置指令一次滤波时间常数 Position command a filtering time constant	5~1750	50	ms	P
Pn111◆	位置指令 S 形滤波时间常数 Ta S-shaped filtering time constant Ta position instruction	5~1200	50	ms	P
Pn112◆	位置指令 S 形滤波时间常数 position instruction Ts S-shaped filtering time constant Ts	5~550	20	ms	P
Pn113▲	位置环前馈增益 The position loop feedforward gain	0-100	0	%	P
Pn114▲	位置环前馈过滤器时间常数 Position loop feedforward filter time constant	1-50	5	ms	P
Pn115	位置调节器增益 1 The position	5-2000	100	%	P

	controller gain 1				
Pn116	位置调节器增益 2 The position controller gain 2	5-2000	100	%	P
Pn117	位置指令源选择 Position command source selection	0~1	0		P
Pn118	内部位置指令暂停方式选择 Internal position instruction suspend mode selection	0~1	0		P
Pn119	内部位置暂停减速时间 Internal position suspended deceleration time	0~10000	50		P
Pn120	内部位置指令 0 脉冲数高位设定 Internal position 0 high pulse number set up	-9999~9999	0	万个脉冲 ten thousand and pulse	P
Pn121	内部位置指令 0 脉冲数低位设定 Internal position instruction 0 pulse number low set	-9999~9999	0	个 a	P
Pn122	内部位置指令 1 脉冲数高位设定 Internal position instruction 1 pulse number high set	-9999~9999	0	万个脉冲 ten thousand and pulse	P
Pn123	内部位置指令 1 脉冲数低位设定 Internal position instruction 1 pulse number low set	-9999~9999	0	个 a	P
Pn124	内部位置指令 2 脉冲数高位设定 Internal position instruction 2 pulse number high set	-9999~9999	0	万个脉冲 ten thousand and pulse	P

Pn125	内部位置指令 2 脉冲数低位设定 Internal position instruction 2 pulse number set low	-9999~9999	0	个 a	P
Pn126	内部位置指令 3 脉冲数高位设定 Internal position instruction 3 pulse high setting	-9999~9999	0	万个 脉冲 ten thous and pulse	P
Pn127	内部位置指令 3 脉冲数低位设定 Internal position instruction 3 pulse number set low	-9999~9999	0	个 a	P
Pn128	内部位置指令 0 运行速度 Internal position command zero speed	0~3000	100	r/min	P
Pn129	内部位置指令 1 运行速度 Internal position command 1 speed	0~3000	100	r/min	
Pn130	内部位置指令 2 运行速度 Internal position command 2speed	0~3000	100	r/min	P
Pn131	内部位置指令 3 运行速度 Internal position command 3 speed	0~3000	100	r/min	P
Pn132	转矩/速度控制切换至位置控制 的方式 Torque/speed control switch to the position control	0~1	0		P
Pn133	转矩/速度控制切换至位置控制 的减速时间 Torque/speed control switch to the position control of the deceleration time	5-10000	100	ms	P
Pn134~ Pn145	内部使用 internal use	-	-	-	

4.2.3 速度控制参数 Speed control parameter

编号 number	名称 name	取值范围 value range	默认值 The default value	单位 unit	适用 apply
Pn146◆	速度指令加减速方式 Speed instruction deceleration mode	0~2	1		S
Pn147◆	速度指令 S 曲线加减速时间常数 Ts Speed instruction S curve and deceleration time constant Ts	5~ 1500	80	ms	S
Pn148◆	速度指令 S 曲线加速时间常数 Ta Speed instruction S curve acceleration time constant of Ta	5~ 10000	80	ms	S
Pn149◆	速度指令 S 曲线减速时间常数 Td Speed instruction S curve deceleration time constant of Td	5~ 10000	80	ms	S
Pn150◆	直线加速时间常数 Linear acceleration time constant	5~30000	80	ms	S
Pn151◆	直线减速时间常数 Linear deceleration time constant	5~30000	80	ms	S
Pn152▲	速度检测滤波时间常数 Speed detection filter time constant	1~380	10	0.1ms	All
Pn153	速度调节器比例增益 1 The speed regulator proportional gain 1	5~ 2000	100	%	All
Pn154	速度调节器积分时间常数 1 Speed regulator integral time constant of 1	5~ 2000	100	%	All
Pn155	速度调节器比例增益 2 The speed regulator proportional gain 2	5~ 2000	100	%	All
Pn156	速度调节器积分时间常数 2 Speed regulator integral time constant 2	5~ 2000	100	%	All
Pn157▲	模拟速度指令平滑过滤时间 Simulation speed instruction smoothing filtering time	1~500	1	0.1ms	S
Pn158	模拟速度指令增益 The directive gain simulation speed	1~1500	300	r/min/ V	S
Pn159	模拟速度指令偏移调整 Simulation speed instruction offset adjustment	-5000~5000	mv		S

Pn160	模拟速度指令方向 Simulation speed instruction direction	0-1	0		S
Pn161	模拟速度指令强制零区间上限 Simulation speed instruction to enforce zero range	0~1000	0	10mv	S
Pn162	模拟速度指令强制零区间下限 Simulation speed instruction to enforce zero range limit	-1000~0	0	10mv	S
Pn163	零速箝位锁定方式 Zero speed clamp lock mode	0-1		0	S
Pn164	零速箝位触发方式 Zero speed clamp is triggered	0~1		0	S
Pn165	零速箝位电平 The clamp level zero speed	0~200	6	r/min	S
Pn166	零速箝位减速时间 Zero speed clamp deceleration time	5~10000	50	ms	S
Pn167	内部位置调节器增益 Internal position controller gain	5~2000	100	%	All
Pn168	速度指令来源 选择 speed instruction source select	0~1	0		S
Pn169	内部速度指令 1 Internal speed reference 1	-5000-5000	0	R/min	S
Pn170	内部速度指令 2 internal speed instruction 2	-5000-5000	0	R/min	S
Pn171	内部速度指令 3 internal speed instruction 3	-5000-5000	0	R/min	S
Pn172	内部速度指令 4 internal speed instruction 4	-5000-5000	0	R/min	S
Pn173	内部速度指令 5 internal speed instruction 5	-5000-5000	0	R/min	S
Pn174	内部速度指令 6 internal speed instruction 6	-5000-5000	0	R/min	S
Pn175	内部速度指令 7 internal speed instruction 7	-5000-5000	0	R/min	S
Pn176	内部速度指令 8 internal speed instruction 8	-5000-5000	0	R/min	S

Pn177	JOG 速度 JOG speed	0~5000	200	r/min	S
Pn178	JOG 加速时间 JOG speed up the time	5~ 10000	100	ms	S
Pn179	JOG 减速时间 JOG Deceleration time	5~ 10000	100	ms	S
Pn180~ Pn185	内部使用 internal use				

4.2.4 转矩控制参数 Torque control parameters

编号 number	名称 name	取值范围 value range	默认值 The default value	单位 unit	适用 apply
Pn186	转矩指令加减速方式 Torque command deceleration mode	0~1	0		T
Pn187▲	转矩指令直线加减速时间常数 torque instruction linear deceleration time constant	1~30000	1	ms	T
Pn188▲	模拟转矩指令平滑过滤时间 Analog torque instruction smooth filtering time	1~500	1	0.1ms	T
Pn189	模拟转矩指令增益 Analog torque instruction gain	1-300	30	%/V	T
Pn190	模拟转矩指令偏移调整 Analog torque instruction offset adjustment	-1500~1500	0	mv	T
Pn191	模拟转矩指令方向 Simulation of torque command direction	0-1	0		T
Pn192	转矩 Q 轴调节器比例增益 1 Q shaft torque regulator proportional gain is 1	5~ 2000	100	%	All
Pn193	转矩 Q 轴调节器积分时间常数 1 Q shaft torque regulator integral time constant of 1	5~ 2000	100	%	All
Pn194	转矩 Q 轴调节器比例增益 2 Proportional gain 2 Q shaft torque regulator	5~ 2000	100	%	All

Pn195	转矩 Q 轴调节器积分时间常数 2 Q shaft torque regulator integral time constant 2	5~ 2000	100	%	All
Pn196	转矩 Q 轴滤波时间常数 1 Torque Q axis filter time constant of 1	1-500	1	0.1ms	All
Pn197	转矩 Q 滤波时间常数 2 Filtering time constant torque Q 2	1~500	1	0.1ms	All
Pn198	转矩控制时限制速度 Torque control speed limit	0~4500	2500	r/min	T
Pn199	转矩控制受限速度来源选择 Source of limited torque control speed choice	0~2	0		T
Pn200	内部转矩 1 The internal torque 1	-300~300	0	%	T
Pn201	内部转矩 2 The internal torque 2	-300~300	0	%	T
Pn202	内部转矩 3 The internal torque 3	-300~300	0	%	T
Pn203	内部转矩 4 The internal torque 4	-300~300	0	%	T
Pn204	转矩指令来源 Torque command source	0~1	0		T
Pn205	转矩 D 轴调节器比例增益 D shaft torque regulator proportional gain	5~2000	100	%	All
Pn206	转矩 D 轴调节器积分时间常数 D shaft torque regulator integral time constant	5~2000	100	%	All
Pn207	速度反馈调节系数 Speed feedback adjustment coefficient	1~3000	100		T
Pn208	跟踪转矩指令判断误差范围 1 track torque instruction judgment error range 1	0~300	5	%	T
Pn209	跟踪转矩指令判断误差范围 2 tracking torque instruction judgment error range 2	0~300	2	%	T
Pn210~ Pn219	内部使用 internal use				

4.2.5 扩展控制参数 Extension control parameters

4.3 参数详解 Parameters

4.3.1 系统参数 System parameters

编号 number	名称 name	取值范围 value range	默认值 The default value	单位 unit	适用 apply
Pn000	开放参数初始化功能 Open parameters initialization function	0~2	1		All

- ▲ 0: 禁止对所有参数进行初始化。Open parameters initialization function
- ▲ 1: 允许对所有参数进行初始化，但不初始化 Pn001(电机代码), Pn159 (模拟速度指令偏移调整), Pn190 (模拟转矩指令偏移调整) 等参数值。Allow to initialize to all parameters, but not initialized Pn001 code (motor), Pn159 (simulated speed instruction offset adjustment), Pn190 (analog torque instruction offset adjustment), and other parameter values
- ▲ 2: 允许对所有参数进行初始化。Allow to initialize all parameters

编号 number	名称 name	取值范围 value range	默认值 The default value	单位 unit	apply
Pn001▲	电机代码 Motor code	3-12	3		All

- ▲ 须设置正确的电机型号代码，电机才能正常工作。驱动器型号与电机型号适配表如下：Must set up the right motor type code, the motor can work normally. Drive model and motor model fit the table below

电机型号 Motor model	Pn001	额定转速 Rated speed (r/min)	额定转 矩 rated torque (N.M)	额定功率 Rated power (W)	KRS 15A	KRS 20A	KRS 30A	KRS 50A	KRS 75A
60st_m00630	0	3000	0.6	200	√	√	√		
60st_m01330	1	3000	1.3	400	√	√	√		
60st_m01930	2	3000	1.9	600	√	√	√		
80st_m01330	3	3000	1.3	400	√	√	√		
80st_m02430	4	3000	2.4	750	√	√	√		
80st_m03520	5	2000	3.5	730	√	√	√		
80st_m04025	6	2500	4	1000	√	√	√		
90st_m02430	7	3000	2.4	750	√	√	√		
90st_m03520	8	2000	3.5	730	√	√	√		
90st_m04025	9	2500	4	1000	√	√	√		
110st_m02030	10	3000	2	600	√	√	√		
110st_m04020	11	2000	4	800	√	√	√		

110st_m04030	12	3000	4	1200		√	√		
110st_m05030	13	3000	5	1500			√		
110st_m06020	14	2000	6	1200	√	√	√		
110st_m06030	15	3000	6	1800			√		
130st_m04025	16	2500	4	1000	√	√	√		
130st_m06015	17	1500	6	1000	√	√	√		
130st_m05025	18	2500	5	1300		√	√		
130st_m06025	19	2500	6	1500			√		
130st_m07725	20	2500	7.7	2000			√		
130st_m10010	21	1000	10	1000	√	√	√		
130st_m10015	22	1500	10	1500		√	√		
130st_m10025	23	2500	10	2600			√	√	√
130st_m15015	24	1500	15	2300			√		
130st_m15025	25	2500	15	3800				√	√
150st_m15025	26	2500	15	3800				√	√
150st_m15020	27	2000	15	3000				√	√
150st_m18020	28	2000	18	3600				√	√
150st_m23020	29	2000	23	4700				√	√
150st_m27020	30	2000	27	5500					√
180st_m17215	31	1500	17.2	2700				√	√
180st_m19015	32	1500	19	3000			√	√	√
180st_m21520	33	2000	21.5	4500				√	√
180st_m27010	34	1000	27	2900				√	√
220st_m67010	35	1000	67	1000					√

编号 number	名称 name	取值范围 value range	默认值 the default value	单位 unit	适用 apply
Pn002▲	控制模式 control mode	0~5	2		All

▲ 各种控制模式如下表： All kinds of control mode in the following table

Pn002	控制模式 control mode
0	转矩模式 Torque mode
1	速度模式 speed mode
2	位置模式 location mode

3	位置/速度模式 location/speed mode
4	位置/转矩模式 location/torque mode
5	速度/转矩模式 speed/torque mode

▲ 设置为 3,4,5 时,模式之间的切换由输入端口 SigIn 的 Cmode 信号状态决定: Set to three, four, five, mode between the switch is determined by the input port SigIn Cmode signal state

Pn002	Cmode	控制模式 control mode
3	OFF	位置模式 location mode
	ON	速度模式 speed mode
4	OFF	位置模式 location mode
	ON	转矩模式 torque mode
5	OFF	速度模式 speed mode
	ON	转矩模式 toeque mode

▲ 控制模式切换方式详见附录 B Please refer to the appendix B for switching control mode

编号 number	名称 name	取值范围 value range	默认值 the default value	单位 unit	适用 apply
Pn003	伺服使能方式 Servo enabled mode	0~1	0		All

▲ 0: 由输入端口 SigIn 的 SON 使能驱动器 By the input port of the SigIn SON can drive

▲ 1: 上电后自动使能驱动器 After power on can automatically make the drive

编号 number	名称 name	取值范围 value range	默认值 the default value	单位 unit	适用 apply
Pn004	伺服断使能停机方式 Servo is broken can stop the way	0~2	0		All

▲ 当使能信号变从有效变为无效时,可设置电机停止运行的方式: When make the can signal from effective becomes invalid, can set the motor to stop running mode

Pn004	电磁制动器 Electromagnetic brake	减速停机 Slowing down	说明 instructions
0	不使用 Do not use	不使用 Do not use	惯性停车 Inertial parking
1	不使用 Do not use	使用 use	减速停车,减速时间由 Pn005 确定 Determined by Pn005 decelerate parking, deceleration time

2	使用 use	不使用 Do not use	电磁制动方式停车（适用带有电磁制动器的电机） Electromagnetic braking parking with electromagnetic brake (for motor)
---	--------	----------------	--

编号 number	名称 name	取值范围 value range	默认值 the default value	单位 unit	适用 apply
Pn005	断使能减速时间 Can make deceleration time	5-10000	100	ms	All

▲ 使能信号从有效变为无效时，使电机减速至零的时间。在减速过程中，若使能信号再次有效，电机仍会先减速至零。Can make the signal from the effective becomes invalid, the motor speed to zero time. If in the process of reduction, enabling signal effectively again, the motor will slow down to zero

编号 number	名称 name	取值范围 value range	默认值 the default value	单位 unit	适用 apply
Pn006	使用/不使用正反驱动禁止 With/without positive driving is prohibited	0-3	0		All

▲ 设置本参数值，可以选择使用或不使用驱动禁止功能，其真值表如下：Set this parameter values, you can choose to use or not use driving ban function, the truth table below

Pn006	正转驱动禁止 Forward driving ban	反转驱动禁止 Reverse driving ban
0	不使用 Do not use	不使用 Do not use
1	不使用 Do not use	使用 use
2	使用 use	不使用 Do not use
3	使用 use	使用 use

编号 number	名称 name	取值范围 value range	默认值 the default value	单位 unit	适用 apply
Pn007	正/反驱动禁止停机减速时间 forward/reverse driving stop deceleration time is prohibited	0-10000	60	ms	All

- ▲ 当发生超程时，SigIn 端口的 ccwl 或 cwl 状态为 OFF，使用 Pn077 可设置是否进行报警检出。超程时，电机可按照减速时间减速，同时清除位置指令脉冲（位置控制），停止后进行内部位置锁定。内部位置增益通过 Pn167 调节。When happening overtravel, SigIn port CCWL or.cwl status is OFF; use Pn077 on whether can be set up alarm detection. Distance, the motor can be in accordance with the slow time to slow down, clear position instruction pulse (position control) at the same time, after stop for internal position lock. Internal position gain through Pn167 regulation

编号 number	名称 name	取值范围 value range	默认值 the default value	单位 unit	适用 apply
Pn008	内部正转转矩限制(CCW) Internal around are torque limit (CCW)	0-300	300	%	All
Pn009	内部反转转矩限制 (CW) Around inside the torque limit (the CW)	-300~0	-300	%	All
Pn010	外部正转转矩限制(CCW) External around are torque limit (CCW)	0-300	300	%	All
Pn011	外部反转转矩限制(CW) Around outside the torque limit (the CW)	-300~0	-300	%	All

- ▲ 设置电机 CCW/CW 方向的转矩限制。内、外部转矩限制同时有效时，实际转矩取较小限制值。Set the CCW/the CW direction of motor torque limit. Internal and external torque limit effectively at the same time, the actual torque smaller limi
- ▲ 外部转矩限制由 SigIn 端口的 TCCWL、TCWL 控制。External torque limit by SigIn TCCWL, TCWL control of the port
- ▲ 有些电机最大输出转矩是额定转矩的两倍，则电机输出的最大转矩自动受限于两倍额定转矩以内。Some motor maximum output torque is twice the rated torque, the maximum torque of the motor output automatically restricted to within two times the rated torque

编号 number	名称 name	取值范围 value range	默认值 the default value	单位 unit	适用 apply
Pn012	正转 (CCW) 转矩过载 1 报警水平 Forward (CCW) torque overload alarm level 1	0-300	200	%	All
Pn013	反转 (CW) 转矩过载 1 报警水平 Inversion (the CW) torque overload alarm level 1	-300-0	-200	%	All

Pn014	转矩过载 1 报警检测时间 Torque overload 1 alarm detection time	0-800	80	100ms	All
Pn015	过载 2 检测时间 Overload 2 testing time	0-150	40	100ms	All

- ▲ 过载 1 报警水平指过载过流相对于电机额定输出电流的百分比,过载能力的范围在 0 与最大输出电流之间。过载 1 的过载能力默认为 2 倍扭矩,在设定的时间内,若持续超过 2 倍输出扭矩,将执行过载 1 保护。Overload 1 alarm level refers to the overload overcurrent rated output current percentage, relative to the motor overload capacity range between 0 and the maximum output current. Torque overload 1 the overload capacity of the default value is 2 times, in the setting time, lasts for more than 2 times the output torque, will perform overload 1 protection
- ▲ 在设定的时间内,电机达到允许的额定扭矩输出倍数时,将执行过载 2 保护。In a set time, the motor to allow the rated torque output ratio, will perform overload 2 protection
- ▲ 若过载水平设置大于相应的内/外部转矩限制值时,过载条件可能得不到满足,保护将起不到作用。If the overload level sets is greater than the corresponding internal/external torque limit, overload conditions may not be met, the protection will not work

编号 number	名称 name	取值范围 value range	默认值 the default value	单位 unit	适用 apply
Pn016▲	编码器分频输出之分子 DA The molecular DA of encoder divider output	1~63	1		All
Pn017▲	编码器分频输出之分母 DB 编码器分频输出之分 母 DB	1~63	1		All

- ▲ 编码器输出电子齿比,用于对编码器脉冲信号进行分频输出。分频值必须满足: $DA/DB \geq 1$ 。例如,编码器为 2500 线,分频值 $DA/DB=25/8$,则分频后的线数: $2500/(DA/DB)=2500/(25/8)=800$ 线

Encoder output, a electronic gear used for dividing the encoder pulse signal output. Frequency division value must be satisfied: $DA/DB \geq 1$. Encoder, for example, to line 2500, DA/DB crossover value = $25/8$, then after frequency division line number: $2500 / (DA/DB) = 2500 / (25/8) = 800$ line

编号 number	名称 name	取值范围 value range	默认值 the default value	单位 unit	适用 apply
Pn018▲	编码器输出脉冲 AB 相 位逻辑取反 Take the encoder output pulse	0-1	0		All

	AB phase logic				
--	----------------	--	--	--	--

▲ 0: 电机逆时针旋转 A 超前 B; 顺时针旋转 B 超前 A

0: motor counterclockwise A, B in advance. Clockwise ahead of A B

▲ 1: 电机逆时针旋转 B 超前 A; 顺时针旋转 A 超前 B

1: motor counterclockwise B ahead; Clockwise ahead of B

编号 number	名称 name	取值范围 value range	默认值 the default value	单位 unit	适用 apply
Pn019▲	额定电流设置 Rated current Settings	0-15	0	A	All
Pn020▲	额定转速设置 Rated speed setting	0~5000	额定转速 Rated speed	r/min	All

▲ 参数设置为 0，则使用厂家设置的默认值；否则，用户必须严格依照电机的额定电流有效值和额定速度及相应的内部正反转矩限制值设置参数值。若设置不当，电机将不能正常运转。依据驱动器型号及电机代码的不同，可达到的最大实际电流值不同。一般用户请勿修改。

Parameter is set to 0, use the manufacturer to set a default value; Otherwise, the user must be strictly in accordance with the motor rated current RMS, rated speed and the corresponding internal positive and negative torque limit setting parameter values. If set incorrectly, the motor will not be able to run properly. According to the code of different types and motor drive, can achieve the largest actual current value is different. Please do not modify the average user.

编号 number	名称 name	取值范围 value range	默认值 the default value	单位 unit	适用 apply
Pn021	到达预定速度 reach to predetermined speed	0~5000	500	r/min	All
Pn022	到达预定速度迟滞比较差值 Hysteresis comparison difference in predetermined speed	0~5000	30	r/min	All
Pn023	到达预定速度检测方向 Reach to predetermined speed detection direction	0-2	0		All

▲ 当电机的运行速度超过设定的判定值时，输出端口 SigOut 的 Sreach 将转变为 ON，否则为 OFF。

When the motor is running at a faster rate than the decision value set, the output port SigOut Sreach will turn ON, or to OFF.

▲ 比较器具有迟滞比较特性。差值设置值过小，输出信号关断频率越高；设置值越大，关断频率小，但同时导致比较器的分辨率降低。例：预定速度设置为 100，差值设置为 10。More instruments include

hysteresis comparison. The setting of the difference is too small, the output signal cut-off frequency is higher; The set value, the greater the cut-off frequency is small, but at the same time reduce the resolution of the comparator. Example: booking speed is set to 100, difference set to 10.

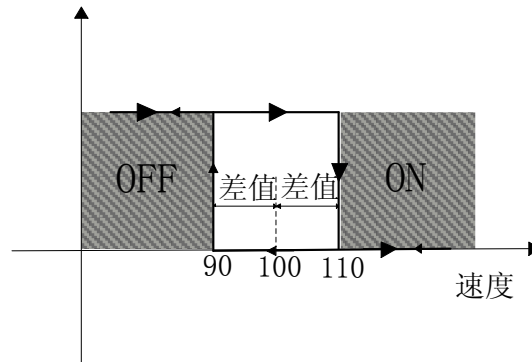

▲ 可设置速度检测方向, 如下表: Can be set up speed detection direction, in the following table

Pn023	比较器 The comparator
0	正反转都检测 Positive & negative were detected
1	只检测正转速度; 反转时, 信号为 OFF Testing only forward speed; Inversion, the signal is OFF
2	只检测反转速度; 正转时, 信号为 OFF Only detect reverse speed; Forward, the signal is OFF

编号 number	名称 name	取值范围 value range	默认值 the default value	单位 unit	适用 apply
Pn024	到达预定转矩 reach to the predetermined torque	0-300	100	%	All
Pn025	到达预定转矩迟滞比较差值 Reach a predetermined torque hysteresis comparison difference	0-300	5	%	All
Pn026	到达预定转矩方向 Reach the predetermined torque direction	0-2	0		All

▲ 当电机的运行转矩超过设定的判定值时, 输出端口 SigOut 的 Treach 将转变为 ON, 否则为 OFF。When the motor running torque than the decision value set, the output port SigOut Treach will turn ON, or to OFF

▲ 可设置转矩检测方向, 如下表: Can install torque detection direction, in the following table:

Pn026	比较器 The comparator
-------	--------------------

0	正反转都检测 Positive & negative were detected
1	只检测正转转矩;反转时, 信号为 OFF。Testing is only around moment; Inversion, the signal is OFF
2	只检测反转转矩;正转时, 信号为 OFF。Only testing around the moment; Forward, the signal is OFF

编号 number	名称 name	取值范围 value range	默认值 the default value	单位 unit	适用 apply
Pn027	零速检测幅度设定 Zero velocity detection range setting	0~1000	10	r/min	All
Pn028	零速检测回差 Zero speed test back to the poor	0~1000	5	r/min	All

- ▲ 当电机运行速度低于设定的速度值时, 输出端口 SigOut 的 zerospeed 转变为 ON, 否则为 OFF。When the speed of the motor speed is lower than the set value, the output port SigOut zerospeed into ON, otherwise to OFF

编号 number	名称 name	取值范围 value range	默认值 the default value	单位 unit	适用 apply
Pn029	电机电磁制动零速检测点 Motor electromagnetic brake testing point zero speed	0~1000	5	r/min	All

- ▲ 仅在使用电磁制动器功能时, 判断电机是否为零速状态。Only when using electromagnetic brake function, state whether the motor is zero speed

编号 number	名称 name	取值范围 value range	默认值 the default value	单位 unit	适用 apply
Pn030	电机静止时电磁制动器延时时 间 Motor static electromagnetic brake delay time	0~2000	0	Ms	All

- ▲ 电机静止时, 电磁制动器制动开始到电机切断电流的延时时间。Motor static, electromagnetic brake braking began to delay time of cut off the current to the motor

- ▲ 使用电磁制动功能时, 伺服断使能方式 Pn005 必须设置为 2。When using the electromagnetic brake function, servo way can make Pn005 must be set to 2

编号 number	名称 name	取值范围 value range	默认值 the default value	单位 unit	适用 apply
Pn031	电机运转时电磁制动器等待	0~2000	500	ms	All

	时间 The motor electromagnetic brake waiting time during operation				
--	--	--	--	--	--

- ▲ 电机运转时，电机切断电流到电磁制动器制动之间的等待时间。Motor operation, cut off the current to the waiting time between electromagnetic brake

编号 number	名称 name	取值范围 value range	默认值 the default value	单位 unit	适用 apply
Pn032	电机运转时电磁制动器动作速度 Electromagnetic brake movement speed while the machine running	0-3000	30	r/min	All

- ▲ 电机运转时，当电机低于此参数设定的速度时，磁制动器开始制动。Motor operation, when the speed of motor is lower than the set parameters, magnetic brakes brake

编号 number	名称 name	取值范围 value range	默认值 the default value	单位 unit	适用 apply
Pn033	原点回归触发方式 The origin is triggered	0~3	0		All

- ▲ 0: 关闭原点回归功能 Close the origin regression function
- ▲ 1: 由输入端口 SigIn 的 GOH 电平触发 By the input port of the SigIn GOH level trigger
- ▲ 2: 由输入端口 SigIn 的 GOH 上升沿触发 By the input port of the SigIn GOH rising along the trigger
- ▲ 3: 上电自动执行 Power on automatically
- ▲ 原点回归执行方式详见附录 F。See the appendix F origin point execution way

编号 number	名称 name	取值范围 value range	默认值 the default value	单位 unit	适用 apply
Pn034	原点回归参考点模式 The origin return reference point model	0~5	0		All

- ▲ 0: 正转找 REF(上升沿触发)作参考点 Forward looking for REF (rising along the trigger) as a reference point
- ▲ 1: 反转找 REF(上升沿触发)作参考点 Inversion for REF (rising along the trigger) as a reference point
- ▲ 2: 正转找 CCWL(下降沿触发)作参考点 Forward looking for CCWL falling edge (trigger) as a reference point
- ▲ 3: 反转找 CWL(下降沿触发)作参考点 Inversion to find.cwl falling edge (trigger) as a reference point
- ▲ 4: 正转找 Z 脉冲作参考点 Forward looking for Z pulse as a reference point
- ▲ 5: 反转找 Z 脉冲作参考点 Pulse inversion for Z as a reference point

注：CCWL 或 CWL 作为参考点时，需设置 Pn006 参数，开启功能。Note: CCWL or.cwl as a reference point, need to set the Pn006 parameters, open the function

编号 number	名称 name	取值范围 value range	默认值 the default value	单位 unit	适用 apply
Pn035	原点回归原点模式 The origin back to the origin model	0~2	0		All

- ▲ 1: 向后找 Z 脉冲作原点 Backward looking for Z pulse as the origin
- ▲ 2: 向前找 Z 脉冲作原点 Forward looking for Z pulse as the origin
- ▲ 3: 直接以参考点上升沿作原点 Directly with reference point rise along the origin

编号 number	名称 name	取值范围 value range	默认值 the default value	单位 unit	适用 apply
Pn036	原点位置偏移高位 The origin position offset high	-9999~9999	0	万个脉冲 ten thousand pulse	All
Pn037	原点位置偏移低位 The origin position offset low	-9999~9999	0	脉冲 pulse	All

- ▲ 找到原点后，加上偏移量(Pn036*10000+ Pn037)作实际原点。After finding the origin, plus the offset (10000 + Pn037 Pn036 *) as a real origin

编号 number	名称 name	取值范围 value range	默认值 the default value	单位 unit	适用 apply
Pn038	原点回归第一速度 The origin back to the first speed	1~3000	200	R/min	All
Pn039	原点回归第二速度 The origin back to the second speed	1~3000	50	R/min	All

- ▲ 执行原点回归操作时，以第一速度寻找参考点，到达参考点后，以第二速度寻找原点。第二速度应小于第一速度。Perform operation on the origin, looking for reference points at the first speed, arrived at the reference point, seeking the origin at the second rate. The second speed should be less than the first speed

编号 number	名称 name	取值范围 value range	默认值 the default value	单位 unit	适用 apply
Pn040	原点回归加速时间 The accelerating time of origin	5~10000	50	ms	All
Pn041	原点回归减速时间 The origin return to slow down time	5~10000	50	ms	All

- ▲ 原点回归执行中，电机从零速加速至额定速度的时间，仅用于原点回归操作。In the execution of origin point, motor from zero speed accelerated to the rated speed of the time, only for the origin returning operation

编号	名称 name	取值范围 value	默认值 the	单位 unit	适用
----	---------	------------	---------	---------	----

number		range	default value		apply
Pn042	原点在位延时 The origin in the delay	0~3000	60	ms	All

- ▲ 到达原点后，延时一段时间，让电机完全静止。延时完成后，输出端口 SigOut 的 HOME 输出变为 ON。
On arriving at the origin, the delay for a period of time, let the motor is perfectly still. After the completion of the delay, output port SigOut HOME output ON

编号 number	名称 name	取值范围 value range	默认值 the default value	单位 unit	适用 apply
Pn043	原点回归完成信号延时 Complete the signal delay of origin	5~3000	80	ms	All

- ▲ HOME 持续的有效时间 。HOME last valid time

编号 number	名称 name	取值范围 value range	默认值 the default value	单位 unit	适用 apply
Pn044	原点回归指令执行模式 The origin return instruction execution mode	0~1	0		All

- ▲ 0: 原点回归完成后，等待 HOME 信号变成 OFF 再接收和执行指令。After the completion of the origin, waiting for the HOME signal into OFF to receive and executes instructions
- ▲ 1: 原点回归完成后立刻接收和执行指令。The origin return immediately after the completion of receiving and executes instructions

编号 number	名称 name	取值范围 value range	默认值 the default value	单位 unit	适用 apply
Pn045	增益切换选择 Gain switch to choose	0~5	5		All

- ▲ 0: 固定第 1 增益。Fixed gain 1
- ▲ 1: 固定第 2 增益。Fixed gain 2
- ▲ 2: 由输入端口 SigIn 的 Cgain 端子控制，OFF 为第 1 增益，ON 为第 2 增益。Controlled by input port SigIn Cgain terminals, OFF as gain 1, ON 2 gain
- ▲ 3: 由速度指令控制，速度指令超过 Pn046 时，切换到第 1 增益。Controlled by speed command, speed command exceeds Pn046, switch to gain 1
- ▲ 4: 由脉冲偏差控制，位置偏差超过 Pn046 时，切换到第 1 增益。Controlled by pulse bias, position deviation exceeds Pn046, switch to gain 1
- ▲ 5: 由电机转速控制，反馈速度超过 Pn046 时，切换到第 1 增益。By the motor speed control, feedback speed exceeds Pn046, switch to gain 1

▲ 增益切换详见附录 A See the appendix A for gain switch

编号 number	名称 name	取值范围 value range	默认值 the default value	单位 unit	适用 apply
Pn046	增益切换水平 Gain switch level	0~30000	80		All
Pn047	增益切换回差 Gain switch back to the poor	0~30000	6		All

▲ 根据 Pn045 参数的设置，切换的条件和单位都不相同：According to Pn045 parameter setting, switching condition and the unit is not the same

Pn044	增益切换条件 Gain switching conditions	单位 unit
3	速度指令 Speed instruction	R/min
4	脉冲偏差 Pulse bias	个脉冲 a pilse
5	电机转速 Motor speed	r/min

编号 number	名称 name	取值范围 value range	默认值 the default value	单位 unit	适用 apply
Pn048	增益切换延迟时间 Gain switch delay time	0~20000	20	0.1ms	All

▲ 增益切换条件满足到开始切换的延迟时间。如果在延迟阶段检测到切换条件不满足,则取消切换。Gain switching conditions meet the delay time to start switch. If detected in delayed phase switching conditions are not met, then cancel the switch

编号 number	名称 name	取值范围 value range	默认值 the default value	单位 unit	适用 apply
Pn049◆	增益切换时间 1 Gain switch time 1	0~15000	0	0.1ms	All
Pn050◆	增益切换时间 2 Gain switch time 2	0~15000	50	0.1ms	All

▲ 增益切换时，当前增益组合在此时间内线性平滑渐变到目标增益组合，组合内的各个参数同时变化。Gain switch, current gain linear smoothing gradient combination in this time to the target gain combination, combination of the various parameters change at the same time

编号 number	名称 name	取值范围 value range	默认值 the default value	单位 unit	适用 apply
Pn051	电机运行最高速度限	0~5000	3000		All

	定 The motor running top speed limit				
--	-------------------------------------	--	--	--	--

- ▲ 用于限定电机运行的最高转速。设定值应小于等于额定转速，否则电机可运行的最高转速为额定转速。
Used to restrict the highest speed of the motor running. Value should be less than or equal to the rated speed, otherwise the motor can run a maximum speed of the rated speed

编号 number	名称 name	取值范围 value range	默认值 the default value	单位 unit	适用 apply
Pn052▲	SigIn1 端口功能分配 SigIn1 port functional allocation	-27~27	1		All
Pn053▲	SigIn 2 端口功能分配 SigIn2port functional allocation	-27~27	2		All
Pn054▲	SigIn 3 端口功能分配 SigIn3 port functional allocation	-27~27	19		All
Pn055▲	SigIn 4 端口功能分配 SigIn4 port functional allocation	-27~27	8		All

- ▲ 1: 具体功能分配参照 SigIn 功能详解表。Specific functional allocation reference SigIn function, a table
- ▲ 2: -1~27 功能号是 1-27 功能号相应的负逻辑，功能相同，有效电平相反。- 1 ~ 27 function number is 1-27 corresponding negative logic function, function is the same, the effective level instead

参数值 Parameter values	SigIn 输入电平 SigIn input level	SigIn 对应功能号 SigIn corresponding function
正值 positive values	低电平 low level	ON
	高电平 high level	OFF
负值 negative	低电平 low level	OFF
	高电平 high level	ON

- ▲ 3: 若同一功能重复分配给不同端口，则端口序号大的端口实际有效，序号小的端口不起作用。例：SigIn1-> 6 ; SigIn 3->6;则第 6 号功能只被分配到 SigIn 3，且是负逻辑，而 SigIn 1 端口状态被忽略。If the same overlapped functions assigned to different port, the port number of ports real effective, small number of port doesn't work. Example: SigIn1 - > 6; SigIn - > 3-6; The functions assigned to SigIn 3, 6 and logic is negative, and SigIn 1 port status is ignored

编号 number	名称 name	取值范围 value range	默认值 the default value	单位 unit	适用 apply
Pn056	SigIn 1 端口滤波时间 SigIn filtering time 1 port	1~1000	2	ms	All
Pn057	SigIn 2 端口滤波时间 SigIn filtering time 2 port	1~1000	2	ms	All

Pn058	SigIn 3 端口滤波时间 SigIn filtering time 3 port	1~1000	2s	ms	All
Pn059	SigIn 4 端口滤波时间 SigIn filtering time 4 port	1~1000	2	ms	All

▲ 对输入端口 SigIn 进行数字滤波。For digital filter input port SigIn

编号 number	名称 name	取值范围 value range	默认值 the default value	单位 unit	适用 apply
Pn060▲	SigOut1 端口功能分配 SigOut1 port functional allocation	-14~14	2		All
Pn061▲	SigOut 2 端口功能分配 SigOut2port functional allocation	-14~14	1		All
Pn062▲	SigOut 3 端口功能分配 SigOut3 port functional allocation	-14~14	4		All
Pn063▲	SigOut 4 端口功能分配 SigOut4port functional allocation	-14~14	7		All

▲ 具体功能分配参照 SigOut 功能详解表。Specific functional allocation reference to SigOut function, a table.

参数值 Parameter values	对应功能号 Corresponding function	SigOut 输出结果 SigOut output
正值 positive values	ON	低电平 low level
	OFF	高电平 high level
负值 negative	OFF	低电平 low level
	ON	高电平 high level

编号 number	名称 name	取值范围 value range	默认值 the default value	单位 unit	适用 apply
Pn064▲	通信方式 Communication mode	0-2	0		All

▲ 0: 不通信 No communication

▲ 1: RS-232

▲ 2: RS-485

▲ 通信协议详见[第七章 Modbus 通信功能](#) See chapter 7 Modbus communication protocol communication function

编号 number	名称 name	取值范围 value range	默认值 the default value	单位 unit	适用 apply
Pn065	通信站点 Communications site	1-254	1		All

▲ 使用 Modbus 通信时，每组驱动器都应预先设置不同的站点号;若重复设定站点号，将导致通信瘫痪。
When using the Modbus communication, drive in each group should be set in advance different sites; If repeat setting site, will lead to paralysis of communication

编号 number	名称 name	取值范围 value range	默认值 the default value	单位 unit	适用 apply
Pn066▲	通信波特率Communication baud rate	0-3	1		All

- ▲ 0 : 4800
- ▲ 1 : 9600
- ▲ 2 : 19200
- ▲ 3 : 38400

编号 number	名称 name	取值范围 value range	默认值 the default value	单位 unit	适用 apply
Pn067▲	通信模式设定 Communication mode setting	0-8	8		All

▲ 参数值定义如下表，详见第七章 Modbus 通信功能 Parameter values are defined as follows table, see chapter 7 of the Modbus communication function

设定 set	说明 instructions
0	7 , N , 2 (Modbus , ASCII)
1	7 , E , 1 (Modbus , ASCII)
2	7 , O , 1 (Modbus , ASCII)
3	8 , N , 2 (Modbus , ASCII)
4	8 , E , 1 (Modbus , ASCII)
5	8 , O , 1 (Modbus , ASCII)
6	8 , N , 2 (Modbus , RTU)
7	8 , E , 1 (Modbus , RTU)
8	8 , O , 1 (Modbus , RTU)

编号 number	名称 name	取值范围 value range	默认值 the default value	单位 unit	适用 apply
Pn068	输入功能控制方式选择寄存器 1 Choose to register 1 input function control way	0~32767	0		All
Pn069	输入功能控制方式选择寄存器 2 Choose to register2 input	0~4095	0		All

	function control way				
--	----------------------	--	--	--	--

▲ 确定功能由通信方式或端口输入方式控制。若不进行通信方式控制，设置 0 即可。Determine the function or port input mode control by way of communication. If you don't communicate mode control, set the zero

Pn068 参数: Pn068 parameters

位 bit	BIT7	BIT6	BIT5	BIT4	BIT3	BIT2	BIT1	BIT0
功能 function	Zero Lock	EMG	TCW	TCCW	CWL	CCWL	Alarm rst	Son
默认值 The default value	0	0	0	0	0	0	0	0

BIT15	BIT14	BIT13	BIT12	BIT11	BIT10	BIT9	BIT8
保留 keep	Cgain	Cmode	TR2	TR1	Sp3	Sp2	Sp1
0	0	0	0	0	0	0	0

Pn069 参数: Pn069 parameters

位 bit	BIT7	BIT6	BIT5	BIT4	BIT3	BIT2	BIT1	BIT0
功能 function	REF	GOH	PC	INH	Pclear	Cinv	Gn2	Gn1
默认值 The default value	0	0	0	0	0	0	0	0

BIT15	BIT14	BIT13	BIT12	BIT11	BIT10	BIT9	BIT8
保留 keep	保留 keep	保留 keep	保留 keep	pstop	ptriger	Pos2	Pos1
0	0	0	0	0	0	0	0

▲ 在通信控制时，确定以上功能由 CN3 上的输入端口或由通信控制来改变。设置为 0，则由 CN3 上的输入端口控制改变；设置为 1，则由通信控制改变。默认全由输入端口控制。例如：son sp3 sp2 sp1 功能通过通信方式控制，其它通过输入端口控制，则设置值为 00000111_00000001(二进制)--> 0x0701(十六进制) -->1793(十进制)，所以设置 Pn065 参数的值为 1793。When the communication control, determine the above function from the input port or on the CN3 from communication control to change. Set to 0, the controlled by the input port on the CN3 change; Is set to 1, is controlled by the communication change. The default all controlled by the input port. For example: son sp3 sp2 sp1 function through communication control, other control, through the input port is set value is 00000111 _00000001 (binary) -- - > 0 x0701 (hexadecimal) -- - > 1793 (decimal), so set Pn065 parameter value is 1793.

编号 number	名称 name	取值范围 value range	默认值 the default value	单位 unit	适用 apply
--------------	---------	---------------------	-----------------------------	---------	-------------

Pn070	输入功能逻辑状态设置 寄存器 1 Input function logic state set register 1	0~32767	32691		All
Pn071	输入功能逻辑状态设置 寄存器 2 Input function logic state set register 2	0~4095	4095		All

▲ 在进行 RS232 或 RS485 通信时，并设置 了 Pn068,Pn069 相应的位由通信控制,对本参数与之对应的位进行置位或清零，即可控制输入功能信号的状态。逻辑 0 为有效状态。On RS232 or RS485 communication, and set the Pn068, Pn069 corresponding controlled by communication, this parameter with the corresponding bit to set or reset, can control the state of the function of input signal. Logic 0 for valid state.

Pn070 参数: Pn070 parameters

位 bit	BIT7	BIT6	BIT5	BIT4	BIT3	BIT2	BIT1	BIT0
功能 function	ZeroLock	EMG	TCW	TCCW	CWL	CCWL	Alarmrst	Son
默认值 The default value	1	0	1	1	0	0	1	1

BIT15	BIT14	BIT13	BIT12	BIT11	BIT10	BIT9	BIT8
保留 keep	Cgain	Cmode	TR2	TR1	Sp3	Sp2	Sp1
0	1	1	1	1	1	1	1

Pn071 参数: Pn071 parameters

位 bit	BIT7	BIT6	BIT5	BIT4	BIT3	BIT2	BIT1	BIT0
功能信号 Function signal	REF	GOH	PC	INH	Pclear	Cinv	Gn2	Gn1
默认值 The default value	1	1	1	1	1	1	1	1

BIT15	BIT14	BIT13	BIT12	BIT11	BIT10	BIT9	BIT8
保留 keep	保留 keep	保留 keep	保留 keep	pstop	ptriger	Pos2	Pos1
0	0	0	0	1	1	1	1

▲ 在通信控制方式下，通过设置本寄存器的位，即可达到 CN3 外部输入信号控制的效果。例如：驱动器在位置控制模式下，要禁止脉冲指令，设置 Pn071 的 BIT4 设置 0，则输入的脉冲变为无效。非通信控制下，设置本参数值，一律无效。In a communication control mode, by setting the register, CN3 external input signal control could be achieved. Drive in position control mode, for example, to

ban pulse command, set Pn071 BIT4 set 0, input pulse becomes invalid. The communication control, set the parameter value, shall be invalid.

注意: 每次上电后, 驱动器会自动载入 Pn070, Pn071 寄存器的值, 并马上执行相应的操作。所以, 在使能电机前, 确定输入功能信号进入正确的工作状态。Note: after each access to electricity, drive will automatically load the Pn070, Pn071 register values, and perform the corresponding operation immediately. So, before enabling the motor to determine the function of input signal into the proper working condition

编号 number	名称 name	取值范围 value range	默认值 the default value	单位 unit	适用 apply
Pn074	风扇开启温度 Fan temperature	30~70	50	°C	All
Pn075	风扇运行方式 Fan operation mode	0~2	0		All

- ▲ 风扇运行方式有: 0: 感温自动运行 Fan operation mode are: 0: heat automatically
- 1: 开机运行 boot operation
 - 2: 不运行 don't run

编号 number	名称 name	取值范围 value range	默认值 the default value	单位 unit	适用 apply
Pn076	紧急停机(EMG)复位方式 Emergency stop reset (EMG)	0-1	0		All

▲ 解除EMG状态OFF后, 清除EMG (AL-14)报警的条件: Lift its state of EMG OFF after the removal of EMG (AL - 14) alarm conditions:

- 0: 必须在伺服使能OFF下, 通过手动或端口SigIn: AlarmRst清除。Must be under the servo can make OFF, by manual or port SigIn: AlarmRst cleared.
- 1: 不管伺服使能ON或OFF, EMG再次变为ON, 会自动清除。Regardless of servo enabled ON or OFF, EMG again into ON, will be automatically removed

▲ 在使能 ON 的状态下, 若外部有指令输入, EMG 报警自动清除后, 指令立即被执行。In can make ON the state, if the external command input, EMG alarm automatically remove, instructions are executed immediately

编号 number	名称 name	取值范围 value range	默认值 the default value	单位 unit	适用 apply
Pn077	正/反驱动禁止检出 Is/the driving ban checked out	0-2	0		All

▲ 若使用了ccw1或cw1功能, 当ccw1或cw1为OFF状态时, 可设置是否发出AL-15报警: If use the function of CCWL or.cwl, when CCWL or.cwl for the OFF state, whether can be set up from AL - 15 police

- 0: 不发出报警。Don't send out alarm
- 1: 电机运行时, 减速停止后, 发出报警, 电机不再通电。Motor is running, reducing stopped, send out alarm, motor is no longer current
- 2: 立刻发出报警, 电机断电, 自由停机。Immediately issued a warning, motor power, free downtime

编号 number	名称 name	取值范围 value range	默认值 the default value	单位 unit	适用 apply
Pn078	电压不足检出 Lack of voltage detection	0~1	1		All

▲ 0: 不检出 not check out

▲ 1: 检出 Check out

编号 number	名称 name	取值范围 value range	默认值 the default value	单位 unit	适用 apply
Pn079	系统状态显示项目选择 The system status display project selection	0-23	0		All

▲ 驱动器上电后，自动进入监视模式菜单Dn000子菜单。默认情况下，按厂家的方式显示系统状态（电机转速），用户可以设置本参数值，使Dn000显示特定的系统状态参数，具体说明参见“监控模式一览表”。

Drive, automatic Dn000 submenu into monitor mode menu. By default, according to the manufacturer to display the system status (motor speed), the user can set the parameter value, so it shows Dn000 particular state of the system parameters, details see the list of "monitoring mode".

0 系统默认(电机运行速度) The default system (motor speed) 1速度指令Speed instruction 2平均转矩The average torque 3 位置偏差量Position deviation value 4交流电源电压 The ac power voltage 5最大瞬时力矩Maximum instantaneous torque 6 脉冲输入频率Pulse input frequency 7散热片温度Temperature of the heat sink 8当前电机运行速度The current motor speed 9 有效输入指令脉冲累计值低位Effective input command pulse accumulative total value is low 10有效输入指令脉冲累计值高位Effective input command pulse accumulative total value is high 11位置控制时，编码器有效反馈脉冲累计值低位Position control, effective feedback pulse encoder accumulative total value is low

12位置控制时，编码器有效反馈脉冲累计值高位Position control, effective feedback pulse encoder cumulative value high 13再生制动负载率 Regenerative braking load factor

14输入端口信号状态Input port signal state 15输出端口信号状态Signal output port state

16模拟转矩指令电压Analog voltage torque instruction 17模拟速度指令电压Simulate the speed reference voltage 18输出功能状态寄存器 Output function status register 19伺服上电后，编码器反馈脉冲累计值低位After power on the servo, pulse encoder feedback accumulative total value is low 20伺服上电后，编码器反馈脉冲累计值高位After power on the servo, pulse encoder feedback accumulative total value is high 21驱动器软件版本 22编码器UVW信 23转子绝对位置Driver software version 22 23 rotor absolute position encoder UVW letter

编号 number	名称 name	取值范围 value range	默认值 the default value	单位 unit	适用 apply
Pn080▲	编码器选择 The encoder to choose	0~1	0		All

▲ 0: 增量式编码器 2500 线 Incremental encoder 2500 line

▲ 1: 绝对式编码器 13 万线 Absolute encoder 130000 line

编号 number	名称 name	取值范围 value range	默认值 the default value	单位 unit	适用 apply
Pn081	用户参数永久写入操作 User preferences permanent write operation	0-1	0		All

▲ 对应辅助模式 Fn001 操作。将当前 Pn000~Pn219 的所有参数值写入到 EEPROM 中。当参数值由 0 变为 1，驱动器就会执行一次写操作。此操作只在通信时有效(Pn064>0)。The corresponding auxiliary mode Fn001 operation. The current Pn000 ~ Pn219 block all parameter value written to the EEPROM. When the parameter value from 0 to 1, the driver will perform a write operation. This operation is only valid at the time of communication (Pn064 > 0)

编号 number	名称 name	取值范围 value range	默认值 the default value	单位 unit	适用 apply
Pn082	SigOut 端口强制输出 SigOut port output	0	0~255		All

▲ 强制 SigOut 端口输出固定电平。通过设置本参数，强制输出端口的电平状态。Mandatory SigOut port output fixed level. By setting the parameters, the force output port level

	保留 keep	SigOut4		SigOut3		SigOut2		SigOut1	
位 bit	BIT15~BIT8	BIT7	BIT6	BIT5	BIT4	BIT3	BIT2	BIT1	BIT0
默认值 The default value	0	0	0	0	0	0	0	0	0

输出端口真值表如下： Output port truth table below

SigOut 2			SigOut 1		
BIT3	BIT2	输出电平 Output level	BIT1	BIT0	输出电平 Output level
0	0	非强制态 Optional state	0	0	非强制态 Optional state
0	1	强制高电平 Forced to high level	0	1	强制高电平 Forced to high level
1	0	强制低电平 Forced to low level	1	0	强制低电平 Forced to low level
1	1	非强制态 Optional state	1	1	非强制态 Optional state

SigOut 4			SigOut 3		
BIT7	BIT6	输出电平 Output level	BIT5	BIT4	输出电平 Output level
0	0	非强制态 Optional state	0	0	非强制态 Optional state

0	1	强制高电平 Forced to high level	0	1	强制高电平 Forced to high level
1	0	强制低电平 Forced to low level	1	0	强制低电平 Forced to low level
1	1	非强制态 Optional state	1	1	非强制态 Optional state

例：输出端口 SigOut2 强制输出低电平，其它端口状态非强制输出，则设置 Pn082 参数值为 8。Example: output port SigOut2 force output low level, other optional output port status, setting Pn082 parameter value is 8.

编号 number	名称 name	取值范围 value range	默认值 the default value	单位 unit	适用 apply
Pn083	低压报警检测幅值 Low pressure alarm detect amplitude	50~280	200	V	All

▲ 当母线电压低于此幅值时，由 Pn078 决定是否发出报警。When the bus voltage is less than the amplitude, the Pn078 decided whether to send out alarm.

编号 number	名称 name	取值范围 value range	默认值 the default value	单位 unit	适用 apply
Pn084	高压报警检测幅值 High pressure alarm detect amplitude	290~380V	365	V	All

▲ 当母线电压高于此幅值时，立即发出报警，以保护内部电子元器件。输入电源电压应在可接受的规格之内，若稍有偏高，可适当提高检测幅值。如果输入电源已远远超出电压规格，不应增加本参数值，否则会损坏驱动器，请另接符合规格的电源。When the bus voltage is higher than the amplitude, immediately issued a warning, in order to protect the internal electronic components. Input power supply voltage should be within the specifications of the acceptable, if slightly on the high side, can be appropriately increase amplitude detection. If the input voltage power supply has been far beyond specification, shall not increase the parameter value, otherwise it will damage the driver, please conform to the specifications of the power supply.

编号 number	名称 name	取值范围 value range	默认值 the default value	单位 unit	适用 apply
Pn085▲	电机极对数 Motor pole logarithmic	1~100	4	对	All

编号 number	名称 name	取值范围 value range	默认值 the default value	单位 unit	适用 apply
Pn086	再生电路放电周期 Renewable circuit discharge cycle	0~2000	70	ms	All

▲当伺服电机运转在发电机模式，再生电力过多时，必须通过再生路放电，否则内部电压过高，损坏驱动器。设置时间越长，电压释放越快，但再生电阻所需功率越大，否则易烧毁再生电阻。具体设置详见[附录 E](#)。When the servo motor running in generator mode, renewable electricity too

much, must through the regeneration way discharge, otherwise the internal voltage is too high, damage to the drive. Set up, the longer the voltage release faster, but the greater the power needed for regenerative resistor, otherwise easy to burn regenerative resistor. See appendix E specific Settings.

4.3.2 位置控制参数 Position control parameters

编号 number	名称 name	取值范围 value range	默认值 the default value	单位 unit	适用 apply
Pn096▲	指令脉冲输入方式 The command pulse input mode	0-2	0		P
Pn097▲	指令脉冲输入方向逻辑选择 Instruction selection logic pulse input direction	0-1	0		P

▲指令脉冲输入方式如下表： Command pulse input mode in the following table:

Pn096		正命令 Forward command	负命令 reverse command
0	脉冲+方向 Pulse + direction		
1	正转 / 反转 脉冲 Forward/reverse pulse		
2	正交脉冲 The orthogonal pulse		

▲ Pn097=0： 输入正命令，电机逆时针(ccw)旋转 Pn097 = 0: input command, the motor rotate counterclockwise (CCW)

Pn097=1： 输入正命令，电机顺时针(cw)旋转 Pn097 = 1: input command, motor rotate clockwise (included)

编号 number	名称 name	取值范围 value range	默认值 the default value	单位 unit	适用 apply
Pn098	脉冲电子齿轮比之分子 1 Pulse electronics gear than the molecules of 1	1~32767	1		P
Pn099	脉冲电子齿轮比之分子 2 Pulse electronics gear than the molecules of 2	1~32767	1		P
Pn100	脉冲电子齿轮比之分子 3 Pulse electronics gear than the molecules of 3	1~32767	1		P

Pn101	脉冲电子齿轮比之分子 4 Pulse electronics gear than the molecules of 4	1~32767	1		P
Pn102▲	脉冲电子齿轮比之分母 Pulse electronics gear than the denominator	1~32767	1		P

▲电子齿轮比必须满足下列条件，否则无法工作：Electronic gear ratio must meet the following conditions, otherwise will not work:

$1/127 \leq \text{电子齿轮比} \leq 127$ Electronic gear or less than 1/127 of 127 or less

▲电子齿轮比之分子 N 由输入端口 SigIn 的 GN1,GN2 决定。分母固定。分子选择如下表：Electronic gear than the molecules of N by the input port of the SigIn GN1, GN2 decision. The denominator is fixed. Molecules to choose in the following table:

GN2	GN1	电子齿轮比分子 N Electronic gear than N
OFF	OFF	分子 1 Molecular 1
OFF	ON	分子 2 Molecular 2
ON	OFF	分子 3 Molecular 3
ON	ON	分子 4 Molecular 4

编号 number	名称 name	取值范围 value range	默认值 the default value	单位 unit	适用 apply
Pn103	位置偏差超出范围设定 Beyond the scope of setting position deviation	1~ 500	50	千个脉冲	P

▲当脉冲偏差计数器的脉冲数超过所设定的值时（即：当前位置与目标位置相差过大），驱动器就发出报警信号。Deviation when the pulse counter pulse count more than the value set (i.e., the current position and target location are too large), drive out alarm signal.

编号 number	名称 name	取值范围 value range	默认值 the default value	单位 unit	适用 apply
Pn104	位置定位完成范围设定 Complete range set position location	0~ 32767	10	脉冲 pulse	P
Pn105	位置定位完成回差设定	0~ 32767	3	脉冲 pulse	P

	Positioning to complete set				
--	-----------------------------	--	--	--	--

▲ 当偏差计数器的剩余脉冲数低于本参数设定值时，输出端口 SigOut 的 Preach 信号就 ON，否则 OFF。

While the rest of the deviation counter pulse number is lower than the parameters setting, output port SigOut Preach signal is ON, or OFF.

编号 number	名称 name	取值范围 value range	默认值 the default value	单位 unit	适用 apply
Pn106	位置定位接近范围设定 Position location close to the range of Settings	0~ 32767	300	脉冲	P
Pn107	位置定位接近回差设定 Position location close to the poor set back	0~ 32767	30	脉冲	P

▲ 当偏差计数器的剩余脉冲数低于本参数设定值时，输出端口 SigOut 的 Pnear 信号就 ON，否则 OFF。

While the rest of the deviation counter pulse number is lower than the parameters setting, output port SigOut Pnear signal is ON, or OFF.

编号 number	名称 name	取值范围 value range	默认值 the default value	单位 unit	适用 apply
Pn108	位置偏差清除方式 Position deviation clear way	0-1	1		P

▲ 位置控制时，可使用 SigIn 的 Pclear 功能，清除位置偏差计数器的值。位置偏差清除发生在：Position control, can use SigIn Pclear function, clear position deviation value of the counter. Position deviation clearance in -

0: Pclear 电平 ON 期间 0: Pclear level ON period

1: Pclear 上升沿时刻(由 OFF 到 ON) 1: Pclear rise along time (from OFF to ON)

编号 number	名称 name	取值范围 value range	默认值 the default value	单位 unit	适用 apply
Pn109◆	位置指令加减速方式 Position command deceleration mode	0-2	1		P

▲ 0: 不使用滤波 Do not use the filter

▲ 1: 一次平滑滤波 A smoothing filter

▲ 2: S 形滤波 S-shaped filtering

编号 number	名称 name	取值范围 value range	默认值 the default value	单位 unit	适用 apply
Pn110◆	位置指令 S 形滤波时间常数 Position command s-shaped	5~1750	50	ms	P

	filtering time constant				
Pn111◆	位置指令 S 形滤波时间常数 Ta S-shaped filtering time constant Ta position instruction	5~1200	50	ms	P
Pn112◆	位置指令 S 形滤波时间常数 Ts S-shaped filtering time constant Ts position instruction	5~550	20	ms	P

▲ 滤波时间常数定义：由当前位置指令频率运行到目标指令频率的时间。滤波时间越长，位置指令的频率平滑性越好，但指令响应延迟越大。在指令脉冲频率阶跃性变化的场合，起到平滑运行电机的作用。滤波对指令脉冲个数没有影响。Filter time constant is defined by the current location instructions frequency operation to the target frequency. Filtering, the longer the better position instruction frequency smoothness, but command the greater the response delay. In instruction pulse frequency step change, have the effect of smooth running motor. The filter has no effect on instruction pulse number.

▲ 滤波时间 $T = T_a + T_s$ 。Ta:直线部分时间，Ta 越小，加减速越快。Ts:弧线部分时间，Ts 越大，速度越平滑，冲击越小。Filtering time $T = T_a + T_s$. Ta: straight line part of the time, the smaller the Ta, the faster the deceleration. Ts: arc part time, Ts, the greater the speed is smooth, the smaller the impact.

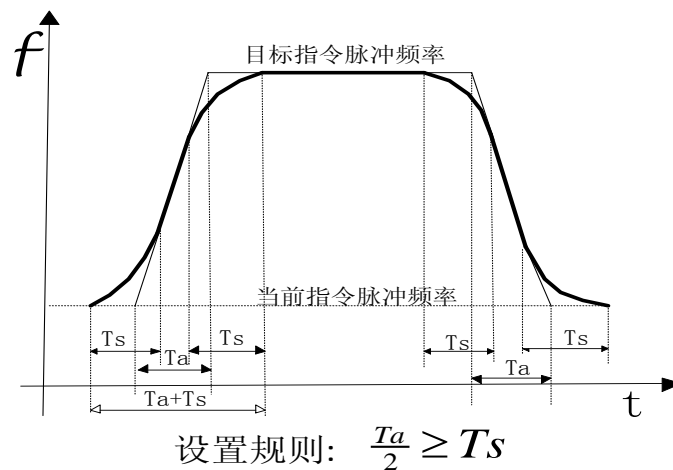

编号 number	名称 name	取值范围 value range	默认值 the default value	单位 unit	适用 apply
Pn113▲	位置环前馈增益 The position loop feedforward gain	0-100	0	%	P
Pn114▲	位置环前馈过滤器时间常数 Position loop feedforward filter time constant	1-50	5	ms	P

▲ 位置控制时，位置前馈直接加于速度指令上，可以减小位置的跟踪误差，提高应答。如果前馈增益过大，可能导致速度过冲。可对前馈命令进行平滑处理。Position control, position feedforward directly on the speed instruction, can reduce the position tracking error, improve the response. If the feedforward gain is too big, can lead to speed overshoot. To smooth the feedforward commands.

编号 number	名称 name	取值范围 value range	默认值 the default value	单位 unit	适用 apply
Pn115	位置调节器增益 1 The position controller gain 1	5-2000	100	%	P
Pn116	位置调节器增益 2 The position controller gain 2	5-2000	100	%	P

▲ 在机械系统不产生振动或是噪音的前提下，增加位置环增益值，以加快反应速度，缩短定位时间。In mechanical systems do not produce under the premise of vibration or noise, increase the position loop gain value, to speed up the reaction rate, shorten the positioning time.

编号 number	名称 name	取值范围 value range	默认值 the default value	单位 unit	适用 apply
Pn117	位置指令源选择 Position command source selection	0~1	0		P

▲ 0: 外部脉冲输入 The external input pulse

▲ 1: 内部位置指令（详见附录 G） Internal location instructions (see appendix G)

编号 number	名称 name	取值范围 value range	默认值 the default value	单位 unit	适用 apply
Pn118	内部位置指令暂停方式选择 Internal position instruction suspend mode selection	0~1	0		P

▲ 0: 当 pstop 触发动作后，ptriger 再次触发时，驱动器根据当前选择的内部位置指令运行。When pstop the trigger action, ptriger trigger again, according to the currently selected internal drive position command to run.

▲ 1: 当 pstop 触发动作后，ptriger 再次触发时，驱动器继续完成上次剩余的内部位置指令脉冲数。When pstop the trigger action, ptriger trigger again, drive to continue to complete the last remaining internal position command pulse number.

编号 number	名称 name	取值范围 value range	默认值 the default value	单位 unit	适用 apply
Pn119	内部位置暂停减速时间 Internal position suspended deceleration time	0~10000	50		P

- ▲ 在内部位置控制时，pstop 下降沿出现后，电机由当前运行速度将减速至 0，其减速时间可由本参数设置(仅用于内部位置控制)。Falling edge position in internal control, pstop, motor by the current running speed will slow down to zero, the deceleration time can be set by this parameter (only for internal position control).

编号 number	名称 name	取值范围 value range	默认值 the default value	单位 unit	适用 apply
Pn120	内部位置指令 0 脉冲数高位设定 Internal position 0 high pulse number set up	-9999~9999	0	万个脉冲 ten thousand pulse	P
Pn121	内部位置指令 0 脉冲数低位设定 Internal position 0 low pulse number set up	-9999~9999	0	个	P
Pn122	内部位置指令 1 脉冲数高位设定 Internal position 1 high pulse number set up	-9999~9999	0	万个脉冲 ten thousand pulse	P
Pn123	内部位置指令 1 脉冲数低位设定 Internal position 0 low pulse number set up	-9999~9999	0	个	P
Pn124	内部位置指令 2 脉冲数高位设定 Internal position 2 high pulse number set up	-9999~9999	0	万个脉冲 ten thousand pulse	P
Pn125	内部位置指令 2 脉冲数低位设定 Internal position 2 low pulse number set up	-9999~9999	0	个	P
Pn126	内部位置指令 3 脉冲数高位设定 Internal position 3 high pulse number set up	-9999~9999	0	万个脉冲 ten thousand pulse	P
Pn127	内部位置指令 3 脉冲数低位设定 Internal position 3 low pulse number set up	-9999~9999	0	个	P

- ▲ 内部位置指令 N (脉冲量) = 内部位置指令 N 脉冲数高位设定值×10000 + 内部位置指令 N 脉冲数低位设定值 Internal location instructions N (pulse) = internal position number N pulse high value x 10000 + internal position instruction N pulse number value low
- ▲ 例：编码器 2500 线，要走行程 12.5 转，则设置 Pn120=12，Pn121=5000。Example: the encoder 2500 line, to go travel 12.5 turn, is set Pn120 = 12, Pn121 = 5000.

编号 number	名称 name	取值范围 value range	默认值 the default value	单位 unit	适用 apply
Pn128	内部位置指令 0 运行速度 Internal position command zero speed	0~3000	100	r/min	P
Pn129	内部位置指令 1 运行速度 Internal position command 1 speed	0~3000	100	r/min	
Pn130	内部位置指令 2 运行速度 Internal position command 2 speed	0~3000	100	r/min	P
Pn131	内部位置指令 3 运行速度 Internal position command 3 speed	0~3000	100	r/min	P

▲ 在执行内部位置指令 N 时，限定电机能运行的最高速度。When performing internal position instruction N, restrict the highest speed of motor can run.

编号 number	名称 name	取值范围 value range	默认值 the default value	单位 unit	适用 apply
Pn132	转矩/速度控制切换至位置控制的方式 Torque/speed control switch to the position control	0~1	0		P

▲控制模式从转矩/速度模式转换至位置控制 (Pn002=3 或 4) 时，为避免发生剧烈的机械冲击，应在较低的速度时进行切换。可设置切换的条件：Control mode from the speed/torque mode conversion to position control (Pn002 = 3 or 4), to avoid severe mechanical shock, should be in low speed switching. The conditions of the switch can be set up:

Pn132=0: 零速度 (zerospeed)

Pn132=1: 减速至零 Slow down to zero

编号 number	名称 name	取值范围 value range	默认值 the default value	单位 unit	适用 apply
Pn133	转矩/速度控制切换至位置控制的 减速时间 Torque/speed control switch to the position control of the deceleration time	5-10000	100	ms	P

▲Pn132=1 时，当 cmode 信号有效，指示控制模式由转矩/速度控制切换至位置控制，电机先减速至零，再切换至位置控制模式。具体时序详见附录 B。Pn132 = 1, when cmode signals effectively, the order control

mode by the torque/speed control switch to the position control, motor slow down to zero, then switch to the position control mode. Please refer to the appendix B for specific timing.

4.3.3 速度控制参数 Speed control parameter

编号 number	名称 name	取值范围 value range	默认值 the default value	单位 unit	适用 apply
Pn146◆	速度指令加减速方式 Speed instruction deceleration mode	0~2	1		S

- ▲ Pn146=0: 不使用速度指令加减速功能 Do not use the speed instruction deceleration function
- Pn146=1: 使用速度指令 S 曲线加减速功能 Using the speed instruction S curve deceleration function
- Pn146=2: 使用直线加减速功能 Use linear deceleration function
- ▲ 在速度控制模式并有外部位置环时,此参数须设置为 0。 In speed control mode and the external position loop, this parameter must be set to 0.

编号 number	名称 name	取值范围 value range	默认值 the default value	单位 unit	适用 apply
Pn147◆	速度指令 S 曲线加减速时间常数 Ts Speed instruction S curve and deceleration time constant Ts	5~ 1500	80	ms	S
Pn148◆	速度指令 S 曲线加速时间常数 Ta Speed instruction S curve acceleration time constant of Ta	5~ 10000	80	ms	S
Pn149◆	速度指令 S 曲线减速时间常数 Td Speed instruction S curve deceleration time constant of Td	5~ 10000	80	ms	S

- ▲ 在速度控制方式时,可以设置速度指令的加减速时间,以平滑地对伺服电机进行启动和停止。 In speed control mode, you can set the speed instruction, deceleration time, in order to smoothly to start and stop the servo motor.
- ▲ Ta: 加速时间: 由 0r/min 起达到额定速度的时间。例如,伺服电机额定转速 3000r/min,若设置时间 3S,则由 0r/min 加速至 1000r/min 的时间为 1S。 Ta: acceleration time: from 0 r/min to rated speed. For example, servo motor rated speed 3000 r/min, if the setting time is 3 s, accelerate from 0 r/min to 1000 r/min for 1 s.
- Td: 减速时间: 由额定速度减至 0r/min 的时间 Deceleration time: by the rated speed reduced to 0 r/min
- Ts: 弧线部分的时间 Arc part time

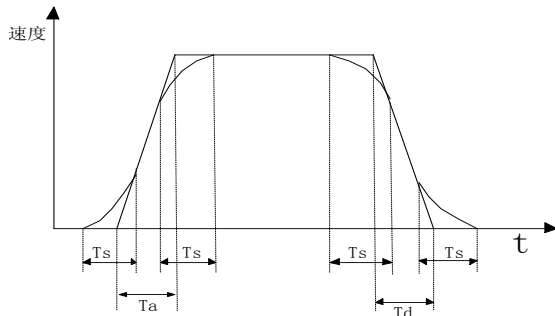

设置规则: $\frac{T_a}{2} \geq T_s, \frac{T_d}{2} \geq T_s$

编号 number	名称 name	取值范围 value range	默认值 the default value	单位 unit	适用 apply
Pn150◆	直线加速时间常数 Linear acceleration time constant	5~30000	80	ms	S
Pn151◆	直线减速时间常数 Linear deceleration time constant	5~30000	80	ms	S

▲ 加速时间常数定义为速度指令从零上升到额定转速的时间。Accelerating time constant is defined as the speed instruction from zero to rated speed.

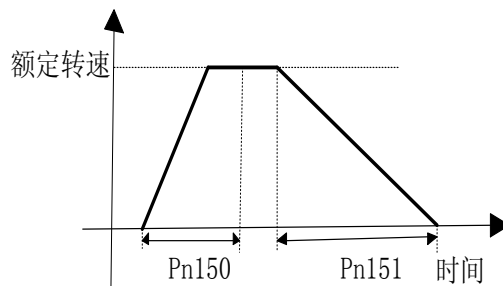

编号 number	名称 name	取值范围 value range	默认值 the default value	单位 unit	适用 apply
Pn152▲	速度检测滤波时间常数 Speed detection filter time constant	1~380	10	0.1ms	All

▲ 参数值越大, 检测到的速度越平滑, 但导致速度响应越慢。太大容易导致振荡, 太小可能导致噪声。
The smooth the speed of the parameter value, the greater the detected, but lead to the slower speed response. Too easy to cause the oscillation, too small may lead to noise.

编号 number	名称 name	取值范围 value range	默认值 the default value	单位 unit	适用 apply
--------------	---------	---------------------	--------------------------	------------	-------------

Pn153	速度调节器比例增益 1 The speed regulator proportional gain 1	5~ 2000	100	%	All
Pn154	速度调节器积分时间常数 1 Speed regulator integral time constant of 1	5~ 2000	100	%	All
Pn155	速度调节器比例增益 2The speed regulator proportional gain 2	5~ 2000	100	%	All
Pn156	速度调节器积分时间常数 2Speed regulator integral time constant 2	5~ 2000	100	%	All

- ▲ 速度环调节器增益直接决定速度控制回路的响应频宽，在机械系统不产生振动或噪音的前提下，增大速度回路增益值，则速度响应加快。Speed loop controller gain directly determine the response of the speed control loop bandwidth, the mechanical system without vibration or noise, increase the speed loop gain value, accelerated the response.
- ▲ 积分时间常数用来调整稳态误差的补偿速度，减小参数值，减小速度控制误差，增加刚性。过小容易引起振动和噪声。Integral time constant is used to adjust the steady-state error compensation rate, decrease the parameter values, reduce the speed control error, increase rigidity. Is too small easy to cause vibration and noise.

编号 number	名称 name	取值范围 value range	默认值 the default value	单位 unit	适用 apply
Pn157▲	模拟速度指令平滑过滤时间 Simulation speed instruction smoothing filtering time	1~500	1	0.1ms	S

- ▲ 设置值越大，输入模拟量响应速度越慢，有利于减小高频噪声干扰，设置越小，响应速度越快，但干扰噪声会变大。The set value, the greater the input analog response speed is slow, is beneficial to reduce the high frequency noise, setting is smaller, the faster response speed, but will get big interference noise.

编号 number	名称 name	取值范围 value range	默认值 the default value	单位 unit	适用 apply
Pn158	模拟速度指令增益 The directive gain simulation speed	1~1500	300	r/min/V	S

- ▲ 模拟量速度指令输入与电机实际运行速度之间的比例关系。电压输入的范围-10~10V。计算公式：速度=输入电压*Pn158。例如：输入电压 10V 时，若设置为 300，相应的速度为 10*300=3000r/min。Analog speed reference input and the ratio between the actual speed motor. The range of input voltage - 10 ~ 10 v. Formula: speed = * Pn158 input voltage. For example: when the input voltage of 10 v, if set to 300, the corresponding rate of 10 * 300 = 3000 r/min.

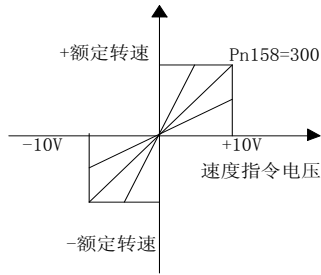

编号 number	名称 name	取值范围 value range	默认值 the default value	单位 unit	适用 apply
Pn159	模拟速度指令偏移调整 Simulation speed instruction offset adjustment	-5000~5000	mv		S

▲ 输入的模拟量可能存在偏移现象，可以通过此参数进行补偿。May occur in the analog input offset phenomenon, can through this parameter.

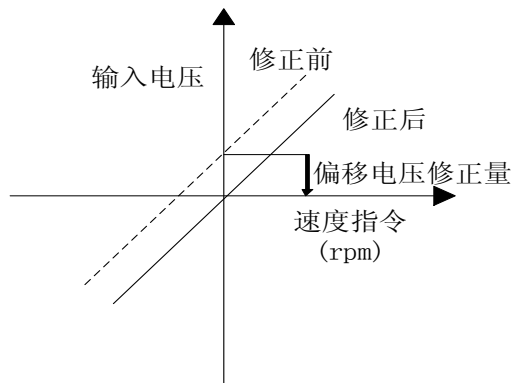

▲ 自动调整偏移，可执行 Fn008 操作。Automatic offset adjusting, perform Fn008 operations.

▲ 手动调整偏移步骤如下：Manually adjust the migration steps are as follows:

- 1: 将外部 0 电位接入模拟输入端口。The external zero potential access to the analog input port
- 2: 置本参数为 0，观察监视模式中 dn17 显示的值。This parameter is zero, the monitor dn17 shows the value of the model.
- 3: 若观察值不为 0，输入负的观察值到本参数内，即可实现调整（注意电压单位转换关系）。If observed values are not zero, negative observation value to the input parameters, can be realized to adjust (note that the voltage unit conversion relationship).

例：dn17=1.12V, Pn159 输入-1120mv 即可。Example: dn17 = 1.12 V, Pn159 input - 1120 mv.

编号 number	名称 name	取值范围 value range	默认值 the default value	单位 unit	适用 apply
Pn160	模拟速度指令方向	0-1	0		S

	Simulation speed instruction direction				
--	--	--	--	--	--

▲ 0: 正电压正转(ccw),负电压反转(cw) Positive voltage forward (CCW), negative voltage inversion (the cw)

▲ 1: 负电压正转(ccw), 正电压反转(cw) Positive voltage forward (CCW), negative voltage inversion (the cw)

编号 number	名称 name	取值范围 value range	默认值 the default value	单位 unit	适用 apply
Pn161	模拟速度指令强制零区间上限 Simulation speed instruction to enforce zero range	0~1000	0	10mv	S
Pn162	模拟速度指令强制零区间下限 Simulation speed instruction to enforce zero range	-1000~0	0	10mv	S

▲ 输入速度指令位于下限与上限之间时，输入指令强制为 0 V 。Input speed instruction lies between floor and ceiling, forced to 0 V input instructions.

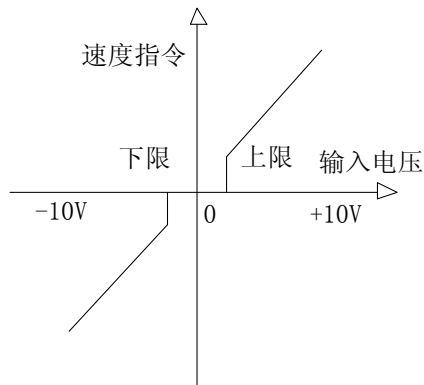

▲ 此时输入电压是经过 PN159 偏移调整后的输入电压。When the input voltage is after adjusting for PN159 offset of the input voltage.

▲ 通过上下限的设置，可使输入指令变为单极性、双极性指令。例：设上限为 0，下限为-1000，则相当于输入指令范围为 0~10V，为正极性速度指令。Through the upper and lower set, can make the input instructions into a single polarity, double polarity. Example: the upper limit of 0, lower limit for - 1000, the equivalent input command range of 0 ~ 10 v, for normal polarity speed commands.

编号 number	名称 name	取值范围 value range	默认值 the default value	单位 unit	适用 apply
Pn163	零速箝位锁定方式 Zero speed clamp lock mode	0-1		0	S

▲ 0: 锁定时, 箝位方式是位置环控制时, 介入内部的环置环控制, 通过 Pn167 设置增益。Lock, the clamping position loop control is the mode, involved in internal ring loop control, gain by Pn167 Settings.

▲ 1: 锁定时, 箝位方式是速度环控制, 速度指令强制为 0, 位置可能因外力作用而发生改变。Locked, clamping way is speed loop control, speed instruction forced to 0, location may change due to external force.

编号 number	名称 name	取值范围 value range	默认值 the default value	单位 unit	适用 apply
Pn164	零速箝位触发方式 Zero speed clamp is triggered	0~1		0	S

▲ 0: SigIn 端口 ZeroLock 为 ON SigIn port ZeroLock to ON

▲ 1: 速度指令低于 Pn165 参数时触发 Triggered when the speed instruction below Pn165 parameters

编号 number	名称 name	取值范围 value range	默认值 the default value	单位 unit	适用 apply
Pn165	零速箝位电平 The clamp level zero speed	0~200	6	r/min	S

▲ 当 Pn164 设置为 1, 且速度指令低于本参数值时, 对电机轴进行锁定。例: 本参数设置为 10r/min, 如果模拟量速度指令在-10r/min~10r/min 范围内时, 则进行减速箝位, 以防止模拟量速度指令在零附近漂移, 导致电机轴不稳定。When Pn164 is set to 1, and the speed instruction below this parameter value, the lock on the motor shaft. Example: this parameter is set to 10 r/min, if the analog speed instruction - 10 r/min ~ 10 r/min, within the scope of the deceleration clamp, in order to prevent the analog speed instruction near the zero drift, lead to the motor shaft instability.

编号 number	名称 name	取值范围 value range	默认值 the default value	单位 unit	适用 apply
Pn166	零速箝位减速时间 Zero speed clamp deceleration time	5~10000	50	ms	S

▲ 当零速箝位触发后, 立即按减速时间进行减速至零, 再进行锁定。When zero velocity clamp when triggered, immediately according to deceleration time to slow down to zero, and then to lock.

编号 number	名称 name	取值范围 value range	默认值 the default value	单位 unit	适用 apply
Pn167	内部位置调节器增益 Internal position controller gain	5~2000	100	%	All

编号 number	名称 name	取值范围 value range	默认值 the default value	单位 unit	适用 apply
-----------	---------	---------------------	--------------------------	---------	----------

Pn168	速度指令来源 选择 Speed reference source	0~1	0		S
-------	-------------------------------------	-----	---	--	---

▲ 在速度控制模式时，可选的速度指令来源：In speed control mode, the optional speed reference source:

Pn168=0: 外部模拟速度指令+内部速度 2~8 External simulation speed instruction within + 2 ~ 8

Pn168=1: 内部速度 1 ~8 Speed within 1 ~ 8

编号 number	名称 name	取值范围 value range	默认值 the default value	单位 unit	适用 apply
Pn169	内部速度指令 1 Internal speed reference 1	-5000-5000	0	R/min	S
Pn170	内部速度指令 2 Internal speed reference 2	-5000-5000	0	R/min	S
Pn171	内部速度指令 3 Internal speed reference 3	-5000-5000	0	R/min	S
Pn172	内部速度指令 4 Internal speed reference 4	-5000-5000	0	R/min	S
Pn173	内部速度指令 5 Internal speed reference 5	-5000-5000	0	R/min	S
Pn174	内部速度指令 6 Internal speed reference 6	-5000-5000	0	R/min	S
Pn175	内部速度指令 7 Internal speed reference 7	-5000-5000	0	R/min	S
Pn176	内部速度指令 8 Internal speed reference 8	-5000-5000	0	R/min	S

▲ 当驱动器的控制模式处于速度控制模式时，速度指令来源由输入端口 SigIn 的 SP1, SP2, SP3 决定: When a drive control mode in speed control mode, the speed reference source by the input port of the SigIn SP1, SP2, SP3 decision:

SP3	SP2	SP1	速度指令 Speed instruction
0	0	0	内部速度 1/外部模拟速度指令(由 Pn168 决定)Internal speed 1 / external analog instruction (decided by Pn168)
0	0	1	内部速度 2 Internal speed 2
0	1	0	内部速度 3 Internal speed 3
0	1	1	内部速度 4 Internal speed 4
1	0	0	内部速度 5 Internal speed 5
1	0	1	内部速度 6 Internal speed 6
1	1	0	内部速度 7 Internal speed 7

1	1	1	内部速度 8 Internal speed 8
---	---	---	-------------------------

注 1: 0 表示 OFF,1 表示 ON。Note 1:0 is OFF, 1 is ON.

注 2: 若 SigIn 端口没有指定 SP3,SP2,SP1 功能, 默认都是 OFF 状态。Note 2: if the SigIn port is not specified SP3, SP2, SP1 function, is OFF by default

编号 number	名称 name	取值范围 value range	默认值 the default value	单位 unit	适用 apply
Pn177	JOG 速度 speed	0~5000	200	r/min	S
Pn178◆	JOG 加速时间 speed up the time	5~ 10000	100	ms	S
Pn179◆	JOG 减速时间 Deceleration time	5~ 10000	100	ms	S

▲ 点动试运行, 可设置电机运行的速度与加减速时间。When commissioning at, can set the speed of the motor running and the deceleration time

4.3.4 转矩控制参数 Torque control parameters

编号 number	名称 name	取值范围 value range	默认值 the default value	单位 unit	适用 apply
Pn186	转矩指令加减速方式 Torque command deceleration mode	0~1	0		T

▲ 0: 不使用转矩指令加减速 Do not use the deceleration torque instruction

▲ 1: 使用转矩指令直线加减速 Using linear deceleration torque instruction

编号 number	名称 name	取值范围 value range	默认值 the default value	单位 unit	适用 apply
Pn187▲	转矩指令直线加减速时间常数 Linear deceleration time constant torque instruction	1~30000	1	ms	T

▲ 时间常数定义为转矩指令由零直线上升到额定转矩的时间。Time constant is defined as a torque command from zero has soared to the rated torque.

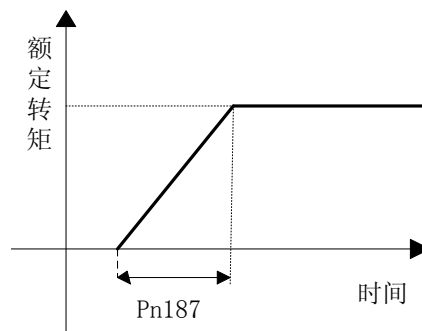

编号 number	名称 name	取值范围 value range	默认值 the default value	单位 unit	适用 apply
Pn188▲	模拟转矩指令平滑过滤时间 Analog torque instruction smooth filtering time	1~500	1	0.1ms	T

▲ 设置值越大，输入模拟量响应速度越慢，有利于减小高频噪声干扰；设置越小，响应速度越快，但干扰噪声会变大。The set value, the greater the input analog response speed is slow, is helpful to reduce the high frequency noise; Setup is smaller, the faster the speed of response, but will get big interference noise.

编号 number	名称 name	取值范围 value range	默认值 the default value	单位 unit	适用 apply
Pn189	模拟转矩指令增益 Analog gain torque instruction	1-300	30	%/V	T

▲ 模拟量转矩指令输入与电机实际输出转矩之间的比例关系。电压输入的范围-10~10V。默认输入电压为 10V，电机达到 3 倍额定转矩，即 $Y=KX=30X$ ， $K=30$ 。Analog torque command input and the ratio between the actual output torque. The range of input voltage - 10 ~ 10 v. The default input voltage of 10 v, motor at 3 times the rated torque, namely = $KX = 30 x$, $Y K = 30$.

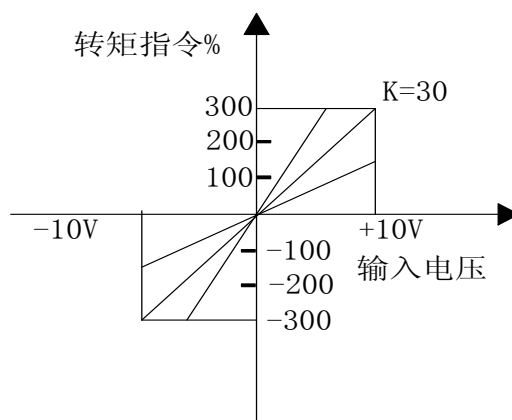

编号 number	名称 name	取值范围 value range	默认值 the default value	单位 unit	适用 apply
Pn190	模拟转矩指令偏移调整 Analog torque instruction offset adjustment	-1500~1500	0	mv	T

▲ 调整方式参考“模拟速度指令偏移调整” Adjust the way reference "simulation speed deviation adjustment directive"

编号	名称 name	取值范围 value	默认值 the	单位 unit	适用 apply
----	---------	------------	---------	---------	----------

number		range	default value		
Pn191	模拟转矩指令方向 Simulation of torque command direction	0-1	0		T

▲ 0: 正电压正转(ccw), 负电压反转(cw) Positive voltage forward (CCW), negative voltage inversion (the cw)

▲ 1: 负电压正转(ccw), 正电压反转(cw) Turn negative voltage is (CCW), positive voltage inversion (the cw)

编号 number	名称 name	取值范围 value range	默认值 the default value	单位 unit	适用 apply
Pn192	转矩 Q 轴调节器比例增益 1 Q shaft torque regulator proportional gain is 1	5~ 2000	100	%	All
Pn193	转矩 Q 轴调节器积分时间常数 1 Q shaft torque regulator integral time constant of 1	5~ 2000	100	%	All
Pn194	转矩 Q 轴调节器比例增益 2 Q shaft torque regulator proportional gain is 12	5~ 2000	100	%	All
Pn195	转矩 Q 轴调节器积分时间常数 2 Q shaft torque regulator integral time constant of 2	5~ 2000	100	%	All

▲ 增大比例增益, 可使 Q 轴电流响应加快。Increase the proportional gain, can make the Q axis current response speed.

▲减小积分时间常数, 可减小 Q 轴电流控制误差。Reduce the integral time constant, can reduce the Q axis current control error

编号 number	名称 name	取值范围 value range	默认值 the default value	单位 unit	适用 apply
Pn196	转矩 Q 轴滤波时间常数 1 Torque Q axis filter time constant of 1	1-500	1	0.1ms	All
Pn197	转矩 Q 滤波时间常数 2 Torque Q axis filter time constant of 2	1~500	1	0.1ms	All

▲ 可抑制机械振动, 设置值越大, 效果越好, 过大会造成响应变慢, 可能引起振荡; 设置值越小, 响应越快, 但受机械条件限制。Inhibits mechanical vibration, the larger the set values, the better the results, will cause slow response and may cause oscillation; Set the value is smaller, the faster the response, but the mechanical conditions.

编号 number	名称 name	取值范围 value range	默认值 the default value	单位 unit	适用 apply
Pn198	转矩控制时限制速度 Torque control speed limit	0~4500	2500	r/min	T

- ▲ 在转矩控制时，电机运行速度限制在本参数范围内。可防止轻载时出现超速现象。出现超速时，介入速度控制来减小实际转矩，但实际转速会略有误差。When the torque control, motor speed limit in this parameter range. There was a phenomenon of speeding can prevent the light load. Speeding, speed control to reduce the actual torque intervention, but the actual speed will be slightly error.

编号 number	名称 name	取值范围 value range	默认值 the default value	单位 unit	适用 apply
Pn199	转矩控制受限速度来源选择 Source of limited torque control speed choice	0~2	0		T

- ▲ Pn199=0: 受参数 Pn198 限制 Restricted by Pn198 parameters
- Pn199=1: 受内部速度指令 1~8 限制。Restricted by internal speed instruction 1 ~ 8
- Pn199=2: 若 Pn204=1,即所有转矩指令来源于内部转矩指令，则速度可受模拟电压速度指令限制。If Pn204 = 1, i.e., all instructions from the internal torque, torque, speed can be restricted by analog voltage speed command
- ▲ 以上所有速度限制值不分正负，多个速度限制发生，受限于最小的速度。All the above speed limit both positive and negative, multiple speed limit, restricted to the minimum speed.
- ▲ 若本参数设置为 1，受内部速度指令限制，则由 sp1,sp2,sp3 决定受限速度值: If this parameter is set to 1, restricted by internal speed instruction, by sp1, sp2, sp3 limited decision speed value:

SP3	SP2	SP1	速度指令 Speed instruction
0	0	0	内部速度 1 Internal speed 1
0	0	1	内部速度 2 Internal speed 2
0	1	0	内部速度 3 Internal speed 3
0	1	1	内部速度 4 Internal speed 4
1	0	0	内部速度 5 Internal speed 5
1	0	1	内部速度 6 Internal speed 6
1	1	0	内部速度 7 Internal speed 7
1	1	1	内部速度 8 Internal speed 8

0 表示 OFF,1 表示 ON. 1 0 means OFF, 1 is ON.

- ▲ 即使设置值超过系统的允许的最高速度，实际速度也会限制在最高速度以下。Even if the setting values than the system allows the highest speed, the actual speed can limit under the highest speed.

编号 number	名称 name	取值范围 value range	默认值 the default value	单位 unit	适用 apply
Pn200	内部转矩 1 The internal torque 1	-300~300	0	%	T

Pn201	内部转矩 2 The internal torque 2	-300~300	0	%	T
Pn202	内部转矩 3 The internal torque 3	-300~300	0	%	T
Pn203	内部转矩 4 The internal torque 4	-300~300	0	%	T

▲ 选择内部转矩控制模式时，使用输入端口 SigIn 的 TR1 TR2 可选择 4 种转矩指令：Select the internal torque control mode, use input port of the SigIn TR1 TR2 can choose 4 kinds of torque command:

TR2	TR1	转矩指令 Torque command
0	0	内部转矩 1 或外部模拟转矩指令（由 Pn204 决定）The external torque 1 or internal analog torque instruction (decided by Pn204)
0	1	内部转矩 2 The external torque 2
1	0	内部转矩 3 The external torque 3
1	1	内部转矩 4 The external torque 4

注 1: 0 表示 OFF, 1 表示 ON NOTE: 1 0 means OFF, 1 is ON.

注 2: 若 SigIn 端口没用指定 TR2, TR1 功能, 默认都是 OFF 状态。Note 2: if the SigIn port doesn't specify TR2, TR1 functions, is OFF by default.

编号 number	名称 name	取值范围 value range	默认值 the default value	单位 unit	适用 apply
Pn204	转矩指令来源 Torque command source	0~1	0		T

0: 外部模拟转矩指令 0: external analog torque command

1: 内部转矩 1 1: internal torque 1

编号 number	名称 name	取值范围 value range	默认值 the default value	单位 unit	适用 apply
Pn205	转矩 D 轴调节器比例增益 D shaft torque regulator proportional gain	5~2000	100	%	All
Pn206	转矩 D 轴调节器积分时间常数 D shaft torque regulator integral time constant	5~2000	100	%	All

▲ 空间矢量调制时，转矩 D 轴的调节器的比例增益和积分时间常数。Space vector modulation, D shaft torque regulator proportional gain and integral time constant.

编号 number	名称 name	取值范围 value range	默认值 the default value	单位 unit	适用 apply
Pn207	速度反馈调节系数 Speed feedback adjustment coefficient	1~3000	100		T

▲ 在转矩控制时，电机速度处于限定速度范围以外，介入速度反馈，以减小实际转矩，从而使速度向限制速度范围内回归。参数设置越小，反馈量越大，调整越快，超速量越小，但太小可能会加剧电机抖动；参数设置太大，调整越慢，有可能已经过速度，起不到限速作用。实际转速会略高于限定速度值。When the torque control, the motor speed in a limited speed range, interventional speed feedback, to reduce the actual torque, so that the speed to limit within the scope of regression. Parameter Settings is smaller, the greater the amount of feedback, the faster the adjustment, the smaller amount of speeding, but is too small will fuel motor shaking; Parameter is set too large, adjust the slower, may have been speed, less than the speed limit. Actual speed will be slightly higher than the limit speed value.

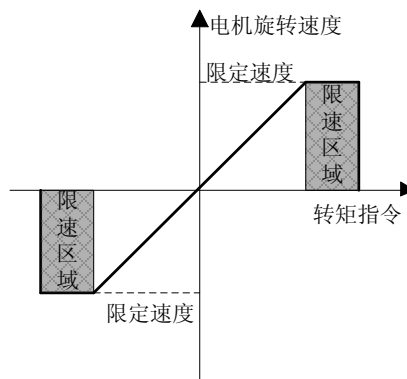

编号 number	名称 name	取值范围 value range	默认值 the default value	单位 unit	适用 apply
Pn208	跟踪转矩指令判断误差范围 1 track torque instruction judgment error range1	0~300	5	%	T
Pn209	跟踪转矩指令判断误差范围 2 track torque instruction judgment error range2	0~300	2	%	T

▲ 要使 SigOut 端口的 TCMDreach 信号输出有效，必须满足以下条件：To make SigOut effective TCMDreach signal output port, must meet the following conditions:

条件 1: 上位机设定的转矩指令必须在判断误差范围 1 内。例：输入的转矩指令 80%，Pn208 设为 5%，驱动器内部对输入的转矩指令进行加减速运算，当计算输出的转矩指令在 75%~85%范围内时，条件 1 就得到满足。Condition 1: PC set torque instruction must be within the error range of 1. Example: input torque command 80%, Pn208 set to 5%, internal drive of input torque instruction in deceleration operation, when calculating the output torque of the instructions within the scope of 75% ~ 85%, condition 1 is satisfied.

条件 2: 检测到的实际电机转矩与输入的转矩指令之差在判断误差范围 2 内。Condition 2: detect the actual motor torque and the difference between the input torque of the instructions in the judgment error range within 2.

4.3.5 扩展控制参数 Extension control parameters

4.4 端口功能详解 Port functions,

4.4.1 SigIn 端口功能详解 SigIn port function explanation

编号 number	符号 symbol	功能 function	功能说明 Functional specifications
0	NULL	无功能指定 No function specified	驱动器对输入状态不产生任何动作。 Drive the input status does not produce any action.
1	Son	伺服使能 servo enable	OFF: 驱动器不使能, 电机不通电。The driver is not enabled, the motor without power ON: 驱动器使能, 电机通电 Drive enabled, the motor power 注: Pn003 参数或 Son 状态决定。 Note: Pn003 parameters or Son state decision.
2	AlarmRs t	报警复位 The alarm reset	有报警时, 且该报警可以清除时, 输入信号上升沿 (OFF 到 ON) 时, 清除该报警。 Alarm, and when the alarm can be clear, the input signal (OFF to ON), the delay to clear the alarm.
3	CCWL	正转驱动禁止 Forward driving ban	OFF: 禁止电机正转 Motor forward is prohibited ON: 允许电机正转 Allow the motor forward 注 1: 若要使用正转驱动禁止功能, 先设置 Pn006 参数, 开启该功能, 再指定到特定到输入端口。默认, 不使用该功能。 Note 1: if you want to use forward driving ban, first set Pn006 parameters, enabled, and designated to a specific to the input port. By default, do not use this feature. 注 2: 电机正常运行时, CCWL 必须处于常闭触点 (ON 状态) Note 2: the normal operation of the motor, CCWL must in a normally closed contact state (ON) 注 3: 原点回归时, 本功能无效。 Note 3: the origin, this function is invalid.
4	CWL	反转驱动禁止 Reverse driving ban	OFF: 禁止电机反转 Prohibit motor reversal ON: 允许电机反转 Allow the motor reversal
5	TCCW	外部正转转矩限制 External forward	OFF: CCW 方向转矩不受 Pn010 参数限制 CCW direction torque Pn010 parameters without limit

		torque limit	<p>ON: CCW 方向转矩受 Pn010 参数限制</p> <p>注: 不管 TCCW 有效还是有效, CCW 方向转矩还受 Pn008 参数限制。Note: whether TCCW efficient or effective, CCW direction torque is also restricted by Pn008 parameters.</p>																																				
6	TCW	外部反转转矩限制 Around outside the torque limit	<p>OFF: CW 方向转矩不受 Pn011 参数限制 The CW direction torque Pn011 parameters without limit</p> <p>ON: CW 方向转矩受 Pn011 参数限制 The CW direction torque Pn011 parameter restrictions</p> <p>注: 不管 TCW 有效还是有效, CW 方向转矩还受 Pn009 参数限制。Note: whether TCW efficient or effective, the CW direction torque is also restricted by Pn009 parameters.</p>																																				
7	EMG	紧急停机 Emergency stop	<p>OFF: 禁止驱动器驱动电机, 切断电机电流 Ban drive motor drive, to cut off the motor current</p> <p>ON: 允许驱动器正常驱动电机 Allow normal drive motor drive</p>																																				
8	Zero Lock	零速箝位 Zero speed clamp	<p>速度控制时: Speed control:</p> <p>OFF: 不锁电机轴 Don't lock the motor shaft</p> <p>ON: 锁住电机轴 Lock the motor shaft</p>																																				
9	SP1	内部速度指令选择 1 Internal speed command option 1	<p>当驱动器的控制模式处于速度控制模式时, 速度指令来源由 SigIn 的 SP1, SP2, SP3 决定: When a drive control mode in speed control mode, the speed reference source by SigIn SP1, SP2, SP3 decision:</p> <table border="1" data-bbox="715 1198 1342 1736"> <thead> <tr> <th>SP3</th> <th>SP2</th> <th>SP1</th> <th>速度指令 Speed instruction</th> </tr> </thead> <tbody> <tr> <td>0</td> <td>0</td> <td>0</td> <td>内部速度 1 internal speed 1/ 外部模拟 External analog 速度指令 External analog</td> </tr> <tr> <td>0</td> <td>0</td> <td>1</td> <td>内部速度 2 internal speed 2</td> </tr> <tr> <td>0</td> <td>1</td> <td>0</td> <td>内部速度 3 internal speed 3</td> </tr> <tr> <td>0</td> <td>1</td> <td>1</td> <td>内部速度 4 internal speed 4</td> </tr> <tr> <td>1</td> <td>0</td> <td>0</td> <td>内部速度 5 internal speed 5</td> </tr> <tr> <td>1</td> <td>0</td> <td>1</td> <td>内部速度 6 internal speed 6</td> </tr> <tr> <td>1</td> <td>1</td> <td>0</td> <td>内部速度 7 internal speed 7</td> </tr> <tr> <td>1</td> <td>1</td> <td>1</td> <td>内部速度 8 internal speed 8</td> </tr> </tbody> </table> <p>注 1: 0 表示 OFF, 1 表示 ON。Note: 0 means OFF, 1 means ON.</p> <p>注 2: 若 SigIn 端口没有指定 SP3, SP2, SP1 功能, 默认都是 OFF 状态。Note 2: if the SigIn port is not specified SP3, SP2,</p>	SP3	SP2	SP1	速度指令 Speed instruction	0	0	0	内部速度 1 internal speed 1/ 外部模拟 External analog 速度指令 External analog	0	0	1	内部速度 2 internal speed 2	0	1	0	内部速度 3 internal speed 3	0	1	1	内部速度 4 internal speed 4	1	0	0	内部速度 5 internal speed 5	1	0	1	内部速度 6 internal speed 6	1	1	0	内部速度 7 internal speed 7	1	1	1	内部速度 8 internal speed 8
SP3	SP2	SP1		速度指令 Speed instruction																																			
0	0	0		内部速度 1 internal speed 1/ 外部模拟 External analog 速度指令 External analog																																			
0	0	1	内部速度 2 internal speed 2																																				
0	1	0	内部速度 3 internal speed 3																																				
0	1	1	内部速度 4 internal speed 4																																				
1	0	0	内部速度 5 internal speed 5																																				
1	0	1	内部速度 6 internal speed 6																																				
1	1	0	内部速度 7 internal speed 7																																				
1	1	1	内部速度 8 internal speed 8																																				
10	SP2	内部速度指令选择 2 Internal speed command option 2																																					
11	SP3	内部速度指令选择 3 Internal speed command option 1																																					

			SP1 function, is OFF by default.																
12	TR1	内部转矩指令选择 1The internal torque command option 1	选择内部转矩控制模式时，利用 TR1 、 TR2 组合，可选择 4 种转矩指令。 Select the internal torque control mode, the use of TR1, TR2 combination, can choose 4 kinds of torque command.																
13	TR2	内部转矩指令选择 The internal torque command																	
			<table border="1"> <thead> <tr> <th>TR2</th> <th>TR1</th> <th>转矩指令 Torque command</th> </tr> </thead> <tbody> <tr> <td>0</td> <td>0</td> <td>内部转矩 1/外部模拟转矩指令 The external torque 1 / internal analog torque command</td> </tr> <tr> <td>0</td> <td>1</td> <td>内部转矩 2 The internal torque 2</td> </tr> <tr> <td>1</td> <td>0</td> <td>内部转矩 3 The internal torque 3</td> </tr> <tr> <td>1</td> <td>1</td> <td>内部转矩 4 The internal torque 4</td> </tr> </tbody> </table> <p>注 1:0 表示 OFF,1 表示 ON Note:0 means OFF,1means ON. 注 2: 若 Sign 端口没用指定 TR2, TR1 功能，默认都是 OFF 状态。 Note 2: if the Sign port doesn't specify TR2, TR1 functions, is OFF by default.</p>	TR2	TR1	转矩指令 Torque command	0	0	内部转矩 1/外部模拟转矩指令 The external torque 1 / internal analog torque command	0	1	内部转矩 2 The internal torque 2	1	0	内部转矩 3 The internal torque 3	1	1	内部转矩 4 The internal torque 4	
TR2	TR1	转矩指令 Torque command																	
0	0	内部转矩 1/外部模拟转矩指令 The external torque 1 / internal analog torque command																	
0	1	内部转矩 2 The internal torque 2																	
1	0	内部转矩 3 The internal torque 3																	
1	1	内部转矩 4 The internal torque 4																	
14	Cmode	控制模式切换 Control mode switch	参数 Pn002 为 3、4、5 时，可进行控制方式切换。 Parameter Pn002 for 3, 4, 5, control mode can be switched.																
15	Cgain	增益切换 Gain switch	当参数 Pn045 为 2 时，通过 Cgain 切换增益组合： When the parameter Pn045 is 2, through Cgain switch gain combination: OFF: 第一增益 The first gain ON: 第二增益 The second gain																
16	Gn1	电子齿轮分子选择 1 Electronic gear molecular option 1	通过 Gn1、 Gn2 组合，选择电子齿轮分子 1~4 By Gn1, Gn2 combination, electronic gear molecules 1 ~ 4																
17	Gn2	电子齿轮分子选择 2 Electronic gear molecular option 2																	
				<table border="1"> <thead> <tr> <th>Gn2</th> <th>Gn1</th> <th>电子齿轮比分子 N Electronic gear than N</th> </tr> </thead> <tbody> <tr> <td>OFF</td> <td>OFF</td> <td>第 1 分子 the 1 molecular</td> </tr> <tr> <td>OFF</td> <td>ON</td> <td>第 2 分子 the 2 molecular</td> </tr> <tr> <td>ON</td> <td>OFF</td> <td>第 3 分子 the 3 molecular</td> </tr> <tr> <td>ON</td> <td>ON</td> <td>第 4 分子 the 4 molecular</td> </tr> </tbody> </table>	Gn2	Gn1	电子齿轮比分子 N Electronic gear than N	OFF	OFF	第 1 分子 the 1 molecular	OFF	ON	第 2 分子 the 2 molecular	ON	OFF	第 3 分子 the 3 molecular	ON	ON	第 4 分子 the 4 molecular
Gn2	Gn1	电子齿轮比分子 N Electronic gear than N																	
OFF	OFF	第 1 分子 the 1 molecular																	
OFF	ON	第 2 分子 the 2 molecular																	
ON	OFF	第 3 分子 the 3 molecular																	
ON	ON	第 4 分子 the 4 molecular																	
18	CINV	指令取反 Instructions in reverse	速度或转矩控制模式下，速度或转矩的指令取反。 The speed or torque control mode, take the speed or torque of the instruction. OFF:正常指令 The normal order ON:指令取反 Instructions in reverse																
19	Pclear	位置偏差清除	清除位置偏差计数器的值，清除方式由 Pn108 参数确定: Clear																

		Position deviation to clear	position deviation value of the counter, clear way by Pn108 parameters: <table border="1"> <tr> <td>Pn108</td> <td>方式 way</td> </tr> <tr> <td>0</td> <td>Pclear 电平 ON 期间 During the Pclear level ON</td> </tr> <tr> <td>1</td> <td>Pclear 上升沿时刻(由 OFF 到 ON) Pclear rise along time (from OFF to ON)</td> </tr> </table>	Pn108	方式 way	0	Pclear 电平 ON 期间 During the Pclear level ON	1	Pclear 上升沿时刻(由 OFF 到 ON) Pclear rise along time (from OFF to ON)
Pn108	方式 way								
0	Pclear 电平 ON 期间 During the Pclear level ON								
1	Pclear 上升沿时刻(由 OFF 到 ON) Pclear rise along time (from OFF to ON)								
20	INH	脉冲输入禁止 Pulse input is prohibited	OFF: 输入指令脉冲允许通过 Pulse allows input instructions ON: 输入指令脉冲被禁止, 忽略 Input instruction pulse have been banned, ignored						
21	PC	比例控制 Proportional control	OFF: 速度环 PI 控制 Speed loop PI control ON: 速度环 P 控制 Speed loop P control						
22	GOH	原点回归触发 The origin return to trigger	详见附录 F See the appendix F						
23	REF	原点回归参考点 The origin return reference point							
24	Pos1	内部位置选择 pos1Pos1 internal location choice	详见附录 G See the appendix G						
25	Pos2	内部位置选择 pos2Pos2 internal location choice							
26	ptriger	触发内部位置指令 Trigger internal position command							
27	pstop	暂停内部位置指令 Suspend internal position command							

4.4.2 SigOut 端口功能详解 SigOut port function explanation

编号 number	符号 symbol	功能 function	功能说明 Functional specifications
0	null	无功能指定 No function specified	
1	Alarm	报警检出 Alarm detection	OFF: 有报警 alarm ON: 无报警 no alarm

2	Ready	伺服准备好 servo is ready	OFF:有报警或故障 There are alarm or malfunction ON:无报警与故障 No alarm and fault
3	Emg	紧急停止检出 Emergency stop checked out	OFF: 没有处于紧急停止状态 Not in a state of emergency stop ON : 处于紧急停止状态 In a state of emergency stop
4	Preach	定位完成 Positioning to complete	位置控制模式时, Position control mode OFF: 位置偏差大于参数 Pn104 设定的值 Pn104 position deviation is greater than the parameter set value ON: 位置偏差小于等于参数 Pn104 设定的值 The value of position deviation less than or equal to Pn104 parameters setting
5	Sreach	速度到达 Speed to reach	OFF: 速度小于 Pn021 设定的值 Speed is less than Pn021 set value ON: 速度大于等于 Pn021 设定的值 Speed is greater than or equal to Pn021 set value
6	Treach	到达预定转矩 reach the predetermined torque	OFF: 转矩小于 Pn024 设定的值 Torque is less than Pn024 set value ON: 转矩大于等于 Pn024 设定的值 The value of torque is greater than or equal to Pn024 set
7	Zero Speed	零速 zero speed	OFF: 速度大于 Pn027 设定的值 Faster than Pn027 set value ON: 速度小于等于 Pn027 设定的值 Speed is less than or equal to Pn027 set value
8	Run	伺服电机通电 Servo motor current	OFF: 电机没有通电 The motor has no electricity ON: 电机通电 motor current
9	BRK	电磁制动 Electromagnetic brake	OFF: 电磁制动器制动 Electromagnetic brake ON : 电磁制动器释放 Electromagnetic brake release
10	HOME	原点回归完成 The origin return to complete	详见附录 F 。 See the appendix F
11	Pnear	定位接近 Located close to	处于位置控制时 in a position control OFF: 位置偏差大于参数 Pn106 设定的值 Pn106 position deviation is greater than the parameter

			<p>set value</p> <p>ON: 位置偏差小于等于参数 Pn106 设定的值 The value of position deviation less than or equal to Pn106 parameters setting</p>
12	TRQL	转矩限制中 The torque limit	<p>OFF: 电机转矩没有被限制 The motor torque is not limited</p> <p>ON: 电机转矩被限制 The motor torque is limited</p> <p>当转矩指令达到 Pn008, Pn009, Pn010, Pn011 中的最小参数值时, TRQL 为 ON。When the torque command reaches Pn008 Pn009, Pn010, the parameter value, the smallest Pn011 TRQL to ON.</p>
13	SPL	速度限制中 The speed limit	<p>转矩控制时, When the torque control</p> <p>OFF: 电机速度没有达到限制值 Motor speed wasn't up to the limiting value</p> <p>ON: 电机速度已达到限制值 Motor speed has reached the limit</p> <p>参见 Pn198,Pn199 说明。Look Pn198 Pn199 instructions</p>
14	TCMDreach	跟踪转矩指令到达 Look Pn198 Pn199 instructions	<p>处于转矩控制时: In torque control:</p> <p>OFF: 电机转矩没有到达上位机设定的转矩指令值 Motor torque did not reach the upper machine set torque instruction value</p> <p>ON: 电机转矩到达上位机设定的的转矩指令值 The setting of motor torque reaches the upper machine set torque instruction value</p> <p>参见 Pn208 、 Pn209 说明。 See Pn208, Pn209 instructions.</p>

第五章 监控参数与操作

Chapter 5 monitoring parameters and operation

5.1 监控面板操作 Monitor panel operation

详见第三章的“[监控模式操作](#)”。As shown in the third chapter "monitoring mode operation"

5.2 监控参数一览表 Monitor the parameter list

编号 number	说明 instruction
dn-00	监控显示选项（默认为电机运行速度），通过设置 Pn079 参数，使 dn-00 显示不同的监控状态。 Monitor display options (the default for motor speed), and by setting the Pn079 parameter, make the dn - 00 show different monitoring status.
dn-01	速度指令(r/min) Speed instruction (r/min)
dn-02	平均转矩(%)The average torque (%)
dn-03	位置偏差量(-9999~9999) （单位：个） Position deviation value (9999 ~ 9999) (unit: a)
dn-04	交流电源电压(V) The ac power voltage (V)
dn-05	最大瞬时力矩（%） The maximum instantaneous torque (%)
dn-06	脉冲输入频率(KHZ) Input pulse frequency (in KHZ)
dn-07	散热片温度（℃） Heat sink temperature (°C)
dn-08	当前电机运行速度 (r/min) The current motor speed (r/min)
dn-09	有效输入指令脉冲累计值低位（-9999~ 9999）（单位：个） Effective input command pulse accumulative total value low (9999 ~ 9999) (unit: a)
dn-10	有效输入指令脉冲累计值高位（-5000~5000）（单位：万个）(脉冲累计值高位超出±5000，则高位置 0，低位不变，重新计数) Effective input command pulse accumulative total value high (5000 ~ 5000) (unit: m) (pulse accumulative total value high more than + 5000, the high position 0, low today, to count)
dn-11	位置控制时，编码器有效反馈脉冲累计值低位（-9999~9999）(单位：个)Effective feedback position control, the encoder pulse accumulative total value is low (9999 ~ 9999) (unit: a)
dn-12	位置控制时，编码器有效反馈脉冲累计值高位（-5000~5000）（单位：万个）(反馈脉冲累计值高位超出±5000，则高位置 0，低位不变，重新计数) Effective feedback position control, the encoder pulse accumulative total value high (5000 ~ 5000) (unit: m) (feedback pulse accumulative total value more than + 5000 high, high position 0, low today, to count)
dn-13	再生制动负载率 Regenerative braking load factor
dn-14	输入端口信号状态，从左至右依次为 SigIn1~SigIn4（1：高电平；0：低电平） Signal input port state, from left to right in turn is SigIn1 ~ SigIn4 (1: high level; 0: low level)
dn-15	输出端口信号状态，从左至右依次为 SigOut1~SigOut4（1：高电平；0：低电平） Output port status signal, from left to right in turn is SigOut1 ~ SigOut4 (1: high level; 0: low level)
dn-16	模拟转矩指令电压(V) Analog torque command voltage (V)
dn-17	模拟速度指令电压(V) Simulation speed reference voltage (V)
dn-18	输出功能状态寄存器 Output function status register

dn-19	伺服上电后，电机的反馈脉冲累计值低位 (-9999~9999) (单位: 个) After power on the servo, motor feedback pulse accumulative total value low (9999 ~ 9999) (unit: a)
dn-20	伺服上电后，电机的反馈脉冲累计值高位 (-5000~5000) (单位: 万个) (反馈脉冲累计值高位超出±5000，则高位置 0，低位不变，重新计数) Electric servo, motor feedback pulse accumulative total value high (5000 ~ 5000) (unit: m) (feedback pulse accumulative total value more than + 5000 high, high position 0, low today, to count)
dn-21	驱动器软件版本 The drive software version
dn-22	编码器 UVW 信号 从左至右依次为 UVW 信号的电平状态 (1: 高电平; 0: 低电平) Encoder UVW signals from left to right in order for the sale of state level (1: high level; 0: low level)
dn-23	转子绝对位置 Rotor absolute position

注: Dn-18 输出功能状态寄存器即 SigOut 端口的逻辑状态, 各 Bit 位如下表所示: Note: Dn - 18 output function status register SigOut port state of logic, namely each Bit position shown in the table below:

Bit 位	Bit7	Bit6	Bit5	Bit4	Bit3	Bit2	Bit1	Bit0
功 能 function	Run	Zero Speed	Treach	Sreach	Preach	Emg	Ready	Alarm
Bit 位	Bit15	Bit14	Bit13	Bit12	Bit11	Bit10	Bit9	Bit8
功 能 function	-	-	-	SPL	TRQL	Pnear	HOME	BRK

Bit 位为 0, 表示功能为 ON 状态, 为 1 则是 OFF 状态。Function for Bit is 0, said ON state, 1 is the OFF state.

第六章 报警及处理 Chapter 6 alarm and processing

6.1 报警清除操 Alarm clearance operations

详见第三章的辅助模式操作的“[报警清除操作](#)”。As shown in the third chapter of the auxiliary model operation "police clearance operation"

6.2 警报内容与对策表 Alarm content and countermeasure

警报显示 Alarm display	清除方式 Clear way	异常报警说明 Abnormal alarm instructions	排除方法 Elimination method
AL-01	重新上电 power on	存储器内容被破坏或存储器芯片损坏 The memory chip memory contents are	1:对参数进行初始化, 观察情况。To initialize the parameters, and observation. 2: 内部芯片损坏, 更换伺服放大器。Internal

		destroyed or damaged	chip is damaged, replace the servo amplifier.
AL-02	重置 reset	在低压不足警报开启的情况下，直流母线电压低于Pn083(200V)时发出的警报。In the case of lack of low-pressure warning, dc bus voltage below Pn083 alarm (200 v).	<p>1: 用电压表测量外部电源电压是否符合规格。如果符合规格,可使用辅助模式 Fn009,进行母线电压校正。The external power supply voltage is measured with a voltmeter is in accordance with the specifications. If conform to the specifications, can use Fn009 auxiliary mode, busbar voltage correction.</p> <p>2: 通过显示屏面板,进入监控模式,观察显示的电压是否与外部电压一致,若相差过大,则内部元件损坏,更换伺服放大器。Through the display panel, into monitor mode, observations show that whether the voltage is consistent with an external voltage, if the difference is too big, the internal components damaged, replace the servo amplifier.</p> <p>3: 电机启动速度过快,负载大,导致内部母线电压被拉低。如果是单相电源接入,请用三相电源接入。Motor start too fast, large load, which leads to the internal bus voltage is lower. If it is single phase power supply access, please use three-phase power supply connection.</p>
AL-03	重新上电 power on	内部直流母线电压高于Pn084(365V)。Internal dc bus voltage is higher than Pn084 (365 v).	<p>1: 用电压表测量外部电源电压是否符合规格。如果符合规格,可使用辅助模式 Fn009,进行母线电压校正。The external power supply voltage is measured with a voltmeter is in accordance with the specifications. If conform to the specifications, can use Fn009 auxiliary mode, busbar voltage correction.</p> <p>2: 通过显示屏面板,进入监控模式,观察显示的电压是否与外部电压一致,若相差过大,则内部元件损坏,更换伺服放大器。Through the display panel, into monitor mode, observations show that whether the voltage is consistent with an external</p>

			<p>voltage, if the difference is too big, the internal components damaged, replace the servo amplifier.</p> <p>3: 在合理的范围内, 适当减小负载惯量或延长加减速时间, 否则需要另加制动电阻。In a reasonable range, appropriate reduction small load inertia or prolonged deceleration, or need additional braking resistor.</p>
AL-04	重新上电 power on	智能功率模块直接产生的报警 Intelligent power module directly produce the report to the alarm	<p>1: 检查电机线 U,V,W 及编码器线是否正常。Check the motor line U, V, W and encoder line is normal.</p> <p>2: 关闭电源半个小时, 重新上电, 如果报警依旧出现, 可能内部功率模块损坏, 请更换伺服放大器。Turn the power off half an hour, electricity again, if the alarm is still there, may be internal power module is damaged, please replace the servo amplifier.</p> <p>3:速度环、电流环比例积分参数设置不当。Speed loop and current loop pid parameter Settings.</p>
AL-05	重置 reset	过载 1 overload 1	<p>Pn014 参数设定的时间内, 持续大于过载能力参数 Pn012 或 Pn013 所设定倍数的电流。Pn014 parameters set period of time for greater than Pn012 overload capacity parameters or Pn013 set by multiples of the current.</p> <p>1: 检查电机线 U,V,W 及编码器线是否正常。Check the motor line U, V, W and encoder line is normal.</p> <p>2:电机加减速频率过高, 延当处长加减速时间、减小负载惯量或换选更大功率容量的伺服电机。Motor high frequency, acceleration and deceleration delay when the director of the deceleration time, reduce the load inertia, or in more powerful capacity</p>

			of servo motor.
AL-06	重新上电 power on	过载 2 overload 2	<p>Pn015 参数设定的时间内,持续大于额定负载 3 倍。排除方法参考过载 1。 Pn015 parameter set period of time, 3 times greater than the rated load. Eliminate overload method reference 1.</p> <p>注: 有些电机只能承受额定负载的 2.5 或 2 倍, 则不按 3 倍作为计算。Note: some motor can only bear the 2.5 or 2 times of the rated load, are not as calculated as 3 times.</p>
AL-07	重置 reset	电机转速过高 Motor speed is too high	<p>1: 检查电机线 U,V,W 及编码器线是否正常。Check the motor line U, V, W and encoder line is normal.</p> <p>2: 降低输入指令的脉冲频率, 或调整电子齿轮比。Reduce the pulse frequency of input instructions, or adjust the electronic gear ratio.</p> <p>3: 速度环比比例积分参数调整不当, 重新调整。Improper speed loop pid parameter adjustment, readjust.</p>
AL-08	重置 reset	伺服放大器散热片过热, 实际温度已超过 70℃ Servo amplifier heat sink overheating, actual temperature has more than 70 °C	<p>1: 重复过载会造成驱动器过热, 请更改电机运行方式。为延长伺服器的寿命, 应在环境温度 55℃ 以下使用, 推荐温度不要超过 40℃。Repeat overload will cause the drive overheating, please change the motor operation mode. For prolonging the life of the server, and should be used under the environment temperature of 55 °C, the recommended temperature does not exceed 40 °C.</p> <p>2: 制动平均功率过载。Brake average power overload.</p>
AL-09	重新上电 power	编码器异常 The encoder abnormal	<p>1: 检查电机编码器接线 是否连接到驱动器。Check whether the motor encoder wiring is connected to the drive.</p> <p>2: 检查电机编码器接口是否虚焊、短路或脱落, 编码器电源线是否正常连接。Check</p>

			<p>whether the motor encoder interface virtual welding, short circuit, or fall off, the encoder the power cord is normal connection.</p> <p>3: 检查编码器的供电电压(5V±5%)。(编码器线较长时, 需要特别注意) Check the encoder voltage (5 v + / - 5%). (encoder line is long, need to pay special attention to)</p>
AL-10	重置 reset	<p>实际接收脉冲频率过高, 超过 600kpps Actually receives the pulse frequency is too high, more than 600 KPPS</p>	<p>1: 电子齿轮比(A/B)设置不当。重新调整 A/B 之比。Electronic gear ratio (A/B) Settings. To adjust the ratio of A/B.</p> <p>2: 降低输入指令的脉冲频率 Reduce the pulse frequency of the input command</p>
AL-11	重置 reset	<p>位置脉冲偏差量大于设定值 位置脉冲偏差量大于设定值</p>	<p>1: 检查电机线 U,V,W 及编码器线是否正常。Check the motor line U, V, W and encoder line is normal.</p> <p>2: 位置指令平滑时间常数设置过大。Position command smoothing time constant set is too large.</p> <p>3:加大位置环增益, 以加快电机的反应速度。Increase the position loop gain, to speed up the response speed of the machine.</p> <p>4: 利用监视模式, 查看电机输出扭力是否达到极限。Using the monitor model, check to see if the motor output torque limits.</p>
AL-12	重置 reset	<p>电流采样回路可能损坏。 Current sampling circuit may be damaged</p>	<p>1: 瞬时电流过大, 超出可检测的范围。The instantaneous electric current too big, is beyond the range of detection.</p> <p>2: 检查电机线 (U,V,W) 是否松动脱落。Check the motor line (U, V, W) whether loose fall off.</p> <p>3:采样回路损坏, 更换伺服放大器。Sampling circuit is damaged, replace the servo amplifier.</p>
AL-13	重新上电 power on	<p>CPU 内部故障 The CPU internal fault</p>	<p>1: 外部干扰过大, 降低干扰。The external interference is too large, reduce the interference.</p> <p>2: CPU 芯片损坏, 更换伺服放大器。The</p>

			CPU chip is damaged, replace the servo amplifier.
AL-14	紧急停止 Emergency stop	紧急停止信号有效 Emergency stop signal is effective	查看端口，是否设置的紧急停止功能，信号触点是否处于常闭状态(ON) See if port, setting of emergency stop function, signal contact is in a normally closed state (ON)
AL-15	驱动禁止异常 Abnormal driving ban	Ccwl 或 Cwl 为 OFF 状态 Ccwl or.cwl to OFF state	1:检查 CCWL,CWL 接线，信号触点是否处于常闭状态(ON)。 Check CCWL,.cwl wiring, the signal contact is in a normally closed state (ON). 2: 若不使用驱动禁止功能，可设置 pn006 参数，将其屏蔽。If do not use the driving ban function, can set pn006 parameters, to block it.
AL-16	制动平均功率过载 Brake average power overload	输入电源电压过高或制动负载率达到 85%以上 The input voltage is too high or braking load rate above 85%	1: 使用监视模式查看输入电压是否超出正常范围 Using the monitoring mode to see if the input voltage is beyond the normal range 2: 降低起停频率 Reduce the start-stop frequency 3: 外接更大功率的再生制动电阻(拿掉内部制动电阻，不能与之并联) External more powerful regenerative braking resistor (remove internal brake resistance, not parallel) 4: 增加减速时间 Increase the deceleration time 5: 再生电阻功率值和电阻值是否设置正确 Renewable power resistance value and the resistance value is set correctly 6: 更换更大功率的电机和驱动器 Change a more powerful motor and drive
AL-17	编码器信号分频输出设置异常 Abnormal encoder signal frequency output	设置的编码器输出分频比不当。 Set the encoder output of frequency division than not.	重新设置 Pn016, Pn017 参数值，必须满足 DA/DB>=1。 Resetting Pn016, Pn017 parameter values, must satisfy the DA/DB > = 1.

	Settings		
AL-18	电机代码设置不当 Improper motor code sets	当前驱动器型号不支持设定的电机型号 The current drive model does not support setting of motor model	参考驱动器与电机型号适配表, 重新设置 Pn001。Reference drive and motor type adapter table, resetting Pn001.

第七章 Modbus 通信功能

Chapter 7 Modbus communication function

7.1 Modbus 通信简介 Modbus communication profile

本驱动器具有 RS-232 和 RS-485 通信接口, 用户可以选择一种接口与驱动通信。通信方法采用 Modbus 传输协议, 可使用下列两种通信模式: ASCII (American Standard Code for information interchange) 模式和 RTU (Remote Terminal Unit) 模式。在通信前, 须先设置好与通信相关的参数 (Pn064~Pn071)。This drive is RS - 232 and RS - 485 communication interface, the user can choose a kind of communication interface and the driver. Communication method adopts the Modbus transfer agreement, can use the following two communication modes: ASCII (American Standard Code for information interchange) mode and the RTU (Remote Terminal Unit) model. Before communication, you must first set up good communication related parameters (Pn064 ~ Pn071).

7.1.2 编码含义 Coding meaning

ASCII 模式: ASCII mode:

每个 8-bit 数据由两个 ASCII 字符组成。例如: 一个 1-byte 数据 78H (十六进制表示法), 以 ASCII 码表示, 包含了 '7' 的 ASCII 码 (37H) 和 '8' 的 ASCII 码 (38H)。Each 8-bit data consists of two ASCII characters. For example, a 78 - byte data 1 h (hexadecimal notation), expressed in ASCII, contains the '7' ASCII (37 h) and "8" ASCII (38 h).

数字 0 至 9、字母 A 至 F 的 ASCII 码, 如下表: The Numbers 0 to 9 and letters A through F ASCII, the following table:

字符符号 Character symbols	'0'	'1'	'2'	'3'	'4'	'5'	'6'	'7'
对应 ASCII 码 Corresponding to the ASCII	30H	31H	32H	33H	34H	35H	36H	37H
字符符号 Character symbols	'8'	'9'	'A'	'B'	'C'	'D'	'E'	'F'
对应 ASCII 码 Corresponding	38H	39H	41H	42H	43H	44H	45H	46H

to the ASCII								
--------------	--	--	--	--	--	--	--	--

RTU 模式: RTU mode:

每个 8-bit 数据由两个 4-bit 的十六进制数据组成, 即一般十六进制组成的数。例如: 十进制 120 用 1-byte 的 RTU 数据表示为 78 H。Each 4-bit 8-bit data by two hexadecimal data, namely the general number of hexadecimal. For example, decimal in 1 120 - byte RTU data representation for 78 H.

7.1.3 数据结构 The data structure

10bit 字符模式 (用于 7bit 数据) 10 bit character mode (for 7 bit data)

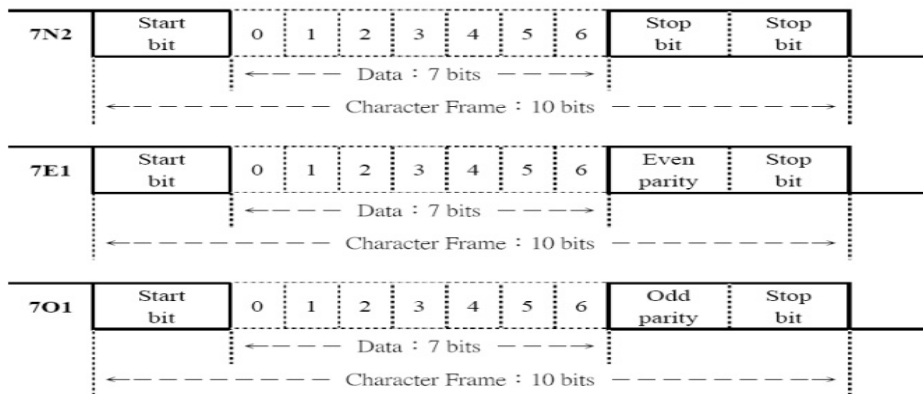

11bit 字符模式 (用于 8bit 数据) 11 bit character mode (for 8 bit data)



7.2 通信协议结构 Communication protocol structure

ASCII 模式 ASCII mode

名称 name	含义 meaning	说明 instruction
Start	通信开始 Communication began	起始字符 ':' (ASCII: 3AH) The starting character ':' (ASCII: 3 ah)
Address	通信地址 The communication address	通信地址，即驱动器的站点号。例如：某驱动器站点号为 32，十六进制为 20H, Address = '2', '0' 即'2'=32H, '0'=30H Address, that is, drive site number. For example: a drive site # 32, hexadecimal for 20 h, Address = '2', '0' or '2' = 32 h, '0' = 30 h
CMD	命令 order	1 字节包含 2 个 ASCII 码。常用命令：03H(读寄存器)、06H ((读单个寄存器), 08H (诊断功能)、10H(写多个寄存器) 1 byte contains two ASCII. Commonly used commands: 3 h (read registers), 6 h ((reading a single register), 8 h (diagnostic function), 10 h (write multiple register)
DATA(n-1)	数据内容 The data content	N 个字=2N 个字节=4N 个 ASCII 码 (N<=8) N = 2 N word bytes = 4 N ASCII (N < = 8)
.....		
DATA(0)		
LRC	校验码 Check code	1 字节包含 2 个 ASCII 码 1 byte contains two ASCII
End 1	结束码 1 The end of the code 1	0DH, 即 CR0 dh, i.e., CR
End 0	结束码 0 The end of the code 0	0AH, 即 LF0 ah, that is, LF

RTU 模式 RTU mode

名称 name	含义 meaning	说明 instruction
Start	通信开始 Communication began	至少 3.5 个字节传输时间的静止时段 The rest time to at least 3.5 bytes transmission time
Address	通信地址 The communication address	通信地址，即驱动器的站点号。例如：某驱动器站点号为 32，十六进

		制为 20H, Address =20H Address, that is, drive site number. For example: a drive site # 32, hexadecimal for 20 h, Address = 20 h
CMD	命令 command	1 字节。常用命令: 03H(读寄存器)、06H ((读单个寄存器), 08H (诊断功能)、10H(写多个寄存器) 1 byte. Commonly used commands: 3 h (read registers), 6 h ((reading a single register), 8 h (diagnostic function), 10 h (write multiple register)
DATA(n-1)	数据内容 data content	N 个字=2N 个字节 (N<=8) Word N = 2 N bytes (N < = 9)
.....		
DATA(0)		
CRC	校验码 Check code	1 字节 1 byte
End 1	结束 The end	至少 3.5 个字节传输时间的静止时段 The rest time to at least 3.5 bytes transmission time

7.3 常用命令码 Commonly used command code

7.3.1 读多个寄存器 Reading a multiple register

03H: 读多个寄存器 Reading a multiple register

说明: 读取 N 个字, N 为 1~8 范围内取值 Instructions: read the N word, N values for 1 ~ 8 scope

例: 从站点号为 01H 的驱动器上读取起始地址 0013H 开始的 2 个字。Example: from the site of 01 h drive read starting address 0013 h 2 words.

1. ASCII 模式 ASCII mode

上位机->驱动器 PC ->
drive

start	‘.’
Address	‘0’

回应->上位机 Response
-> PC (OK)

start	‘.’
Address	‘0’

回应->上位机
Response -> PC (Error)

start	‘.’
Address	‘0’

		'1'
cmd		'0'
		'3'
数据起始地址 Data source address	高位 high bit	'0'
	低位 low bit	'1'
读寄存器个数 Read the register number		'0'
		'0'
LRC		'E'
		'7'
END1(CR)		0DH
END0(LF)		0AH

		'1'
cmd		'0'
		'3'
数据字节数 Data bytes		'0'
		'4'
地址 0013H 内容 Address 0013 h content	高位 high bit	'0'
	低位 low bit	'0'
地址 0014H 内容 Address 0014 h content	高位 high bit	'3'
	低位 low bit	'2'
地址 0014H 内容 Address 0014 h content	高位 high bit	'0'
	低位 low bit	'0'
LRC		'A'
		'B'
END1(CR)		'C'
		0DH
END0(LF)		0AH

		'1'
cmd		'8'
		'3'
异常码 Abnormal code		'0'
		'2'
LRC		'7'
		'A'
END1(CR)		0DH
END0(LF)		0AH

2. RTU 模式

上位机->驱动器 PC -> drive

Address		01H
CMD		03H
数据起始地址 Data source address	高位 high bit	00H
	低位 low bit	13H

回应->上位机 Response
-> PC (OK)

Address		01H
CMD		03H
数据字节数 Data bytes		04H
0013H 地址的内容 The content of the address	高位 high bit	00H
	低位 low bit	

回应->上位机 Response
-> PC (Error)

Address		01H
CMD		83H
异常码 Abnormal code		02H
CRC 低位 low bit		00H

读寄存器个数 Read the register number	00H	content of the 0013 h address	低位 low bit	32H	CRC 高位 high bit	F1H
	02H		0014H 地址的内容 The content of the 0014 h address	高位 high bit		
CRC 低位 low bit	35H	content of the 0014 h address	低位 low bit	0AH		
CRC 高位 high bit	CEH	CRC 低位 low bit		DBH		
		CRC 高位 high bit		FBH		

7.3.2 写单个寄存器 Write a single register

06H: 写单个寄存器 Write a single register

说明: 写一个字到寄存器。 Description: write a word to the register.

例如: 驱动器站号为 01, 写数据起始地址为 0013H, 写入数据 100(64H)。 For example: drive station number of 01, write data initial address is 0013 h, write data, 100 (64 h).

1. ASCII 模式 ASCII MODE

上位机->驱动器 PC -> drive

start	‘.’
Address	‘0’
	‘1’
cmd	‘0’
	‘6’
数据起始地址 Data source address	高位 high bit ‘0’
	‘0’
Data source address	低位 low ‘1’
	‘3’

回应->上位机 Response -> PC (OK)

start	‘.’
Address	‘0’
	‘1’
cmd	‘0’
	‘6’
数据起始地址 Data source address	高位 high bit ‘0’
	‘0’
Data source address	低位 low ‘1’
	‘3’

回应->上位机 Response -> PC (Error)

start	‘.’
Address	‘0’
	‘1’
cmd	‘8’
	‘6’
异常码 Abnormal code	‘0’
	‘3’
LRC	‘7’
	‘6’

	bit	
数据内容 (word 格式)		'0'
		'0'
The data content (word format)		'6'
		'4'
LRC		'8'
		'2'
END1(CR)		0DH
END0(LF)		0AH

	bit	
数据内容 (word 格式)		'0'
		'0'
The data content (word format)		'6'
		'4'
LRC		'8'
		'2'
END1(CR)		0DH
END0(LF)		0AH

END1(CR)	0DH
END0(LF)	0AH

2. RTU 模式 RTU MODE

上位机->驱
动器 PC ->
drive

Address	01H	
CMD	06H	
数据 起始 地址 Data source address	高位 high bit	00H
	低位 low bit	13H
数据内容 (word 格式) The data content (word format)		00H
		64H
CRC 低位 low bit	79H	
CRC 高位 high bit	E4H	

回应->上位机 Response ->
PC (OK)

Address	01H	
CMD	06H	
数据起始 地址 Data source address	高位 high bit	00H
	低位 low bit	13H
数据内容 (word 格 式) The data content (word format)	F4H	00H
	48H	64H
CRC 低位 low bit	79H	
CRC 高位 high bit	E4H	

回应->上位机
Response -> PC
(Error)

Address	01H
CMD	86H
异常码 Abnormal code	03H
CRC 低位 low bit	02H
CRC 高位 high bit	61H

7.3.3 诊断 diagnosis

08H: 诊断功能 Diagnostic function

说明: 使用子功能码 0000H, 检查在 Master 和 Slaver 之间的传输信号。数据内容可为任意数。Note: use 0000 h subfunction code, check the signal transmission between the Master and Slaver. The data content can be any number.

例如: 对站点为 01H 的驱动器使用诊断功能。For example: the site of 01 h drive using diagnostic function

1. ASCII 模式

上位机->驱动器 PC -> drive		回应->上位机 Response -> PC (OK)		回应->上位机 Response -> PC (Error)	
start		start		start	
Address		Address		Address	
cmd		cmd		cmd	
子功能码 Subroutine code	高位 high bit	子功能码 Subroutine code	高位 high bit	异常码 Abnormal code	'0'
					'3'
	低位 low bit		低位 low bit	LRC	'7'
					'4'
数据内容 (word 格式) The data content (word format)		数据内容 (word 格式) The data content (word format)		END1(CR)	
				END0(LF)	
LRC		LRC			
END1(CR)		END1(CR)			
END0(LF)		END0(LF)			

2. RTU 模式 RTU mode

上位机->驱动器 PC ->
drive

Address		01H
CMD		08H
子功能码 Subroutine code	高位 high bit	00H
	低位 low bit	00H
数据内容 (word 格式) The data content (word format)	高位 high bit	86H
	低位 low bit	31H
CRC 低位 low bit		43H
CRC 高位 high bit		BFH

回应->上位机
Response -> PC
(OK)

Address		01H
CMD		08H
子功能码 Subroutine code	高位 high bit	00H
	低位 low bit	00H
数据内容 (word 格式) The data content (word format)	高位 high bit	86H
	低位 low bit	31H
CRC 低位 low bit		43H
CRC 高位 high bit		BFH

回应->上位机
Response -> PC
(Error)

Address		01H
CMD		88H
异常码 Abnormal code		03H
CRC 低位 low bit		06H
CRC 高位 high bit		01H

7.3.4 写多个寄存器 Write multiple register

10H: 写多个寄存器 Write multiple register

说明：将 N 个字写到连续寄存器中，N 最大为 8 (08H)。Note: write the N word to register in a row, the N maximum 8 h (08).

例如：将 100 (0064H)、300 (012CH) 写到局号为 01 伺服驱动器的起始地址 0013H 的连续两个寄存器中。For example: 100 (0064 h), 300 (012 ch) writes JuHao for 01 servo drives the starting address of 0013 h two consecutive registers.

1. ASCII 模式 ASCII MODE

上位机->驱动器
PC -> drive

start		‘:’
Address		‘0’
		‘1’
cmd		‘1’
		‘0’
数据起始地址 Data source address	高位 high bit	‘0’
	低位 low bit	‘0’
		‘1’
	‘3’	
写寄存器个数 Write the register number		‘0’
		‘0’
		‘0’
		‘2’
数据字节数 Data bytes		‘0’
		‘4’
写数据到 0013H Write data to the 0013 h	高位 high bit	‘0’
	低位 low bit	‘0’
		‘6’
	‘4’	

回应->上位机 Response
-> PC (OK)

start		‘:’
Address		‘0’
		‘1’
cmd		‘1’
		‘0’
数据起始地址 Data source address	高位 high bit	‘0’
	低位 low bit	‘0’
		‘1’
	‘3’	
写寄存器个数 Write the register number		高位 high bit
		‘0’
		低位 low bit
		‘0’
LRC		‘4’
		‘1’
END1(CR)		0DH
END0(LF)		0AH

回应->上位机 Response
-> PC (Error)

start		‘:’
Address		‘0’
		‘1’
cmd		‘9’
		‘0’
异常码 Abnormal code		‘0’
		‘3’
LRC		‘6’
		‘C’
END1(CR)		0DH
END0(LF)		0AH

写数据到 0014H Write data to the 0014 h	高位 high bit	'0'
		'1'
	低位 low bit	'2'
		'C'
LRC		'4'
		'5'
END1(CR)		0DH
END0(LF)		0AH

2. RTU 模式

上位机->驱动器 PC ->
drive

Address		01H
CMD		10H
数据起始地址 Data source address	高位 high bit	00H
	低位 low bit	13H
写寄存器个数 Write the register number	高位 high bit	00H
	低位 low bit	02H
数据字节数		04H

回应->上位机 Response
-> PC (OK)

Address		01H
CMD		10H
数据起始地址 Data source address	高位 high bit	00H
	低位 low bit	13H
写寄存器个数 Write the register number	高位 high bit	00H
	低位 low bit	02H

回应->上位机
Response -> PC
(Error)

Address		01H
CMD		90H
异常码 Abnormal code		03H
CRC 低位 low bit		0CH
CRC 高位 high bit		01H

Data bytes		
写数据到 0013H Write data to the 0013h	高位 high bit	00H
	低位 low bit	64H
写数据到 0014H Write data to the 0014h	高位 high bit	01H
	低位 low bit	2CH
CRC 低位 low bit		F3H

CRC 低位 low bit	B0H
CRC 高位 high bit	0DH

位有符号整数。A signed integer.

注 2: 写单个寄存器, 上位机需用 5.5ms 左右时间, 以等待驱动器完成内部数据存储器的烧写; 同理, 写 N 个寄存器 (N<=8), 则上位机需要 5.5ms*N 等待时间, 才能再发送写命令。 Note 2: write a single register, PC must be about 5.5 ms, waiting for the driver to complete the internal data storage of burning; By the same token, the register write N (N < = 8), the upper machine needs 5.5 ms * N waiting time, to send the write command.

注 3: 读取 Dn-13 参数时, 实际电压值=读取值/100。 Note 3: read the Dn - 13 parameters, the actual voltage value = value read / 100.

7.3.5 校验码计算 Check code to calculate

1. LRC 校验 LRC England check

ASCII 模式采用 LRC (Longitudinal Redundancy Check) 校验码。LRC 校验是计算 Address、CMD、起始数据地址及数据内容之总和, 将总和结果以 256 为单位, 取余数 (若总和结果为 150H, 则只取 50H) 后, 再计算其补码, 最后得到的结果为 LRC 校验码。ASCII mode using LRC England (Longitudinal Redundancy Check) Check code. LRC England calibration is to calculate the Address, CMD, initial data Address and the sum total of the data content will be combined results in 256, modulo (if the sum of the results for 150 h, then only take 50 h), to calculate its complement, the final results for LRC England check code.

例: 从站点 01 H 伺服驱动器的 0013 地址读取 2 个字 (word)。 Example: 01 H servo drive from site 0013 address read 2 word (word)

start		‘.’
Address		‘0’
		‘1’
cmd		‘0’
		‘3’
数据起始地址 Data source address	高位 high bit	‘0’
		‘0’
	低位 low bit	‘1’
		‘3’
读寄存器个数 Read the register number		‘0’
		‘0’
		‘0’
		‘2’
LRC		‘E’
		‘7’
END1(CR)		0DH
END0(LF)		0AH

从 Address 的数据加至最后一个数据: From the Address data add to the last data:

01 H + 03H + 00H + 13H + 00H + 02H = 19H, 因 19H 的补码为 E7H, 所以 LRC 为 ‘E’, ‘7’ 01 H + 3 H + 00 00 H + 13 H + H + 02 H = 19 H, for 19 H complement E7H, so LRC England as the 'E', '7'

2. CRC 校验 CRC check

RTU 模式采用 CRC (Cyclical Redundancy Check) 校验码。循环冗余校验 (CRC) 域为两个字节, 包含一个二进制 16 位值。附加在报文后面的 CRC 的值由发送设备计算。接收设备在接收报文时重新计算 CRC 的值, 并将计算结果于实际接收到的 CRC 值相比较。如果两个值不相等, 则为错误。RTU mode adopts CRC (Cyclical Redundancy Check) Check code. Cyclic redundancy check (CRC) domain into two bytes, containing a binary 16-bit value. Attached to the message behind the CRC value calculated by the transmitting device. When receiving device on the receiving message to recalculate the CRC value, and the calculated results compared to actually receives the CRC value. If the two values are not equal, is wrong.

CRC 的计算, 开始对一个 16 位寄存器预装全 1。然后将报文中的连续的 8 位子节对其进行后续的计算。只有字符中的 8 个数据位参与生成 CRC 的运算, 起始位, 停止位和校验位不参与 CRC 计算。CRC calculation, to a 16-bit registers with full 1. Then put the message in the continuous section 8 of the seats on the subsequent calculations. Only the characters of the eight data bits participate in the operation of generating CRC, start bit, stop bits and parity bit CRC calculation will not be involved.

生成 CRC 的过程为: To generate CRC process as follows:

1. 将一个 16 位寄存器装入十六进制 FFFF (全 1). 将之称作 CRC 寄存器. The a 16-bit registers into hexadecimal FFFF. (1) all will be referred to as the CRC register.
2. 将报文的第一个 8 位字节与 16 位 CRC 寄存器的低字节异或, 结果置于 CRC 寄存器. The first 8 bytes of a message with a 16-bit CRC register low byte exclusive or, result in CRC register.
3. 将 CRC 寄存器右移 1 位 (向 LSB 方向), MSB 充零. 提取并检测 LSB. The CRC register moves to the right one to the LSB (direction), the MSB filling zero. Extraction and detection of LSB.
4. (如果 LSB 为 0): 重复步骤 3 (另一次移位). (if the LSB of 0) : repeat step 3 (another shift).
(如果 LSB 为 1): 对 CRC 寄存器异或多项式值 0xA001 (1010 0000 0000 0001). (if the LSB to 1) : the CRC register exclusive or polynomial value 0 xa001 (1010, 0000, 0000, 0001).
5. 重复步骤 3 和 4, 直到完成 8 次移位. 当做完此操作后, 将完成对 8 位字节的完整操作. Repeat steps 3 and 4 until complete displacement of 8 times. As after this action, will complete the full operation of eight bytes.
6. 对报文中的下一个字节重复步骤 2 到 5, 继续此操作直至所有报文被处理完毕. For the next byte of message repeat steps 2 to 5, this operation until all message being processed.
7. CRC 寄存器中的最终内容为 CRC 值. CRC register the final content for CRC value.
8. 当放置 CRC 值于报文时, 高低字节必须交换. 低位字节首先发送, 然后是高位字节 When the CRC value is placed on a message, high and low byte must exchange. Byte is sent first, and then the high byte

例如: 从站点号为 01 H 的驱动器读取 2 个字 (word), 读取起始地址为 0200 H 地址. 从 Address 至数据的最后一位所计算出的 CRC 寄存器的最后内容为 0704 H, 则其指令格式如下所示, 注意, 04H 在 07 H 的前面传送. For example: from the site of 01 H drive reads two words (word), reading the starting address of 0200 H address. The last of the data from the Address to calculate the CRC register at the end of the content is 0704 H, is the instruction format as shown below, note that the front of the 04 H in H.

Address		01H
CMD		03H
数据起始地址 Data source address	高位 high bit	02H
	低位 low high	00H
数据长度 (以 word 计算) Data length (in terms of word)		00H
		02H
CRC 低位 low bit		04H
CRC 高位 high bit		07H

CRC 生成范例: CRC generation paradigm:

下面以 C 语言产生 CRC 值。此函数需要两个参数：The following CRC value by C language. This function requires two parameters:

unsigned char * data;//数据起始地址，用于计算 CRC 值 Unsigned char * data;// data source address, used to calculate the CRC value

unsigned char length;//数据长度 Unsigned char length;// data length

此函数将返回 unsigned integer 类型的 CRC 值。This function returns the unsigned integer type of CRC value.

unsigned int crc_chk(unsigned char * data,unsigned char length)

```
{
    int i,j;
    unsigned int crc_reg=0xFFFF;
    While(length- -)
    {
        Crc_reg ^=*data++;
        for(j=0;j<8;j++)
        {
            If(crc_reg & 0x01)
            {
                crc_reg=( crc_reg >>1)^0xA001;
            }else
            {
                crc_reg=crc_reg >>1;
            }
        }
    }
    return crc_reg;
}
```

7.3.6 异常码 Abnormal code

在通信过程中，可能会产生通信错误，常见错误事件如下表：In the process of communication, may create a communication error, common error event in the following table:

通信错误事件 Communication error event	伺服驱动器应对方法 Servo driver approach
读写参数时，数据地址不正确； Read/write parameters, data address is not correct;	请求不作处理，并返回一个错误异常码 The request for processing, and abnormal return an error code
写参数时，写数据个数超过最大值 或数据不在此参数的取值范围内; Write parameters, data number	请求不作处理，并返回一个错误异常码 The request for processing, and abnormal return an error code

more than the maximum or not within the scope of this parameter;	
数据传输错误或者校验码(LRC、CRC、奇偶检验)错误 Data transmission errors or check code (LRC England, CRC, parity check) error	数据被丢弃, 不返回响应, 上位机应将请求作为超时状态处理 Data is discarded, not returns the response, PC should be request as state handling overtime

驱动器发送错误异常码时, 将命令功能码加上80H后一起传送给ModBus 主站系统。异常码如下表: Drive send error exception code, will command function code plus 80 h after send the ModBus master station system together. Abnormal code in the following table:

01 H	伺服驱动器不能识别请求的功能码 The function of the servo driver does not recognize the request code
02 H	请求给出的数据地址非法Data address illegal request
03 H	请求给出的数据在伺服驱动器中不允许 (读写数据个数超过驱动器允许最大值或写数据值不在参数的取值范围内) Request the data given in the servo driver does not allow (read and write data number more than drive to allow maximum or write data value is beyond the scope of parameter values)
04 H	伺服驱动器已经在开始执行请求, 但不能完成该请求。 Servo drives are beginning to execute the request, but can't complete the request.

7.4 伺服参数、状态信息通信地址 The servo parameters, the state information communication address

数据地址 Data address		含义 meaning	说明 instructions	操作 operation
十六进制 hexadecimal	十进制 The decimal system			
0000H~00EFH	0 ~ 239	参数设置区 Parameter setting area	对应 Pn000~Pn239 Corresponding Pn000 ~ Pn239	可读可写 Can read but write
0164H~016DH	356 ~ 365	报警记录区 Alarm recording area	在 Fn000 中可以查看, 对应 Sn--0~Sn--9 In Fn000 can view, corresponding Sn - 0 to Sn - 9	只读 read-only
0170H~0185H	368 ~ 389	数据监控区 Data monitoring area	对应 Dn000~Dn021	只读

附录 The appendix

附录 A 增益切换 Appendix A gain switch

第一增益 The first gain		第二增益 The second gain	
参数 parameter	名称 name	参数 parameter	名称 name
Pn153	速度调节器比例增益 1 The speed regulator proportional gain 1	Pn155	速度调节器比例增益 2 The speed regulator proportional gain 2
Pn154	速度调节器积分时间常数 1 Speed regulator integral time constant of 1	Pn156	速度调节器积分时间常数 2 Speed regulator integral time constant of 2
Pn192	转矩 Q 轴调节器比例增益 1Q shaft torque regulator proportional gain is 1	Pn194	转矩 Q 轴调节器比例增益 2Q shaft torque regulator proportional gain is 2
Pn193	转矩 Q 轴调节器积分时间常数 1 Q shaft torque regulator integral time constant of 1	Pn195	转矩 Q 轴调节器积分时间常数 2 Q shaft torque regulator integral time constant of 2
Pn196	转矩 Q 轴滤波时间常数 1Torque Q axis filter time constant of 1	Pn197	转矩 Q 滤波时间常数 2Torque Q axis filter time constant of 2
Pn115	位置调节器增益 1 The position controller gain 1	Pn116	位置调节器增益 2 The position controller gain 2

注：增益切换时，必须处于合适的控制模式，设置参数 Pn046 的条件合适，才能满足增益切换条件，进行切换。 Note: gain switch, must be in the right control mode, the setting parameters Pn046 conditions are right, to meet gain switching conditions, to switch.

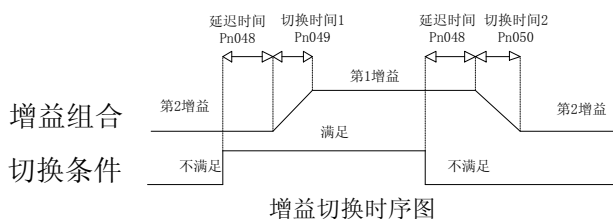

附录 B 控制模式切换 Appendix B control mode switch

B.1 位置/速度控制模式切换 Position/speed control mode switch

使用控制切换(cmode), 可通过输入控制端口SigIn接点进行位置控制模式和速度控制模式的切换。Using the control switch (cmode), can be controlled by input port SigIn contact for position control and speed control mode switch.

cmode和控制模式的关系如下所示。Cmode relationship with control mode is shown below.

Cmode	控制模式control mode
OFF	位置控制模式Position control mode
ON	速度控制模式Speed control mode

可以在零速度状态时进行控制模式的切换。但为了安全起见, 请在伺服电机停止时进行切换。从位置控制模式切换到速度控制模式时, 滞留脉冲将被清除。电机使能前, 请先确定要进入的控制模式 (cmode引脚的状态)。电机使能时, 切换方式有两种, 时序图如下所示: Can be in the state of zero speed control mode switch. But to be on the safe side, please switch with the servo motor stopped. From the position control mode switch to the speed control mode, the trapped pulse will be cleared. Before the machine can make, please make sure to enter the control mode (state) of cmode pin. Motor can make, there are two main ways to switch, sequence diagram as shown below:

▲Pn132=0:

只有零速度状态下, 切换信号发生改变, 模式切换才有效; 如果不在零速度状态下, 切换信号发生了改变, 随后信号进入零速度状态, 则不发生模式切换。Only the zero velocity condition, switching signal changes, the mode switch is valid; If not zero velocity state, the switching signal is changed, then enter into the state of zero speed signal, the mode switch does not occur.

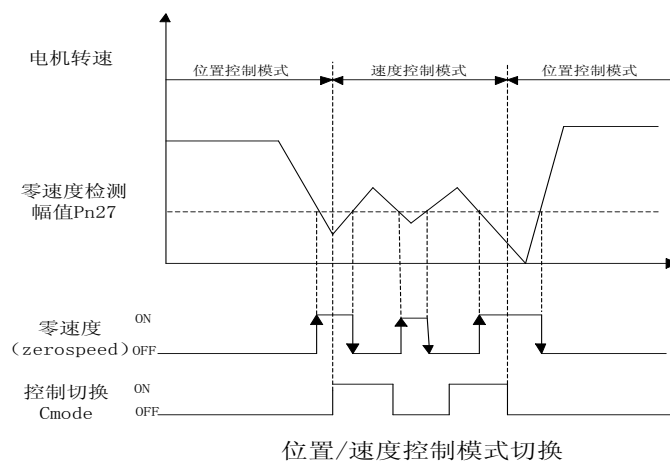

▲Pn132=1:

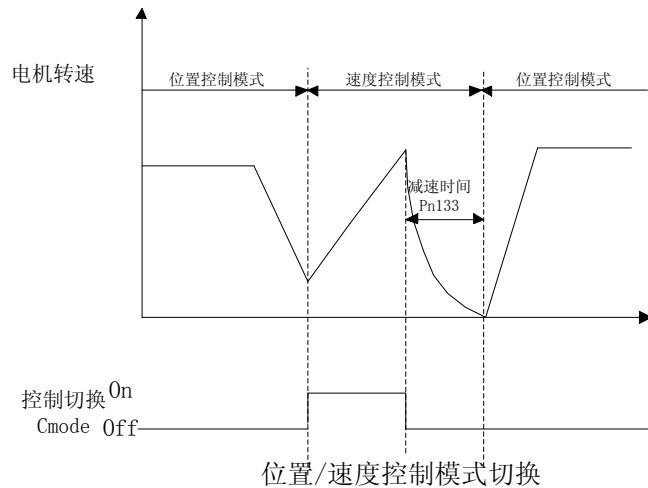

B.2 位置/转矩控制模式切换 Position/torque control mode switch

使用控制切换(cmode), 可通过输入控制端口SigIn接点进行位置控制模式和转矩控制模式的切换。cmode和控制模式的关系如下所示。Using the control switch (cmode), can be controlled by input port SigIn contact position control mode and the torque control mode switching. Cmode relationship with control mode is shown below.

Cmode	控制模式control mode
OFF	位置控制模式position control mode
ON	转矩控制模式Torque control mode

可以在零速度状态时进行控制模式的切换。但为了安全起见, 请在伺服电机停止时进行切换。从位置控制模式切换到转矩控制模式时, 滞留脉冲将被清除。电机使能时, 切换方式有两种, 时序图如下所示: Can be in the state of zero speed control mode switch. But to be on the safe side, please switch with the servo motor stopped. From the position control mode switch to the torque control mode, the trapped pulse will be cleared. Motor can make, there are two main ways to switch, sequence diagram as shown below:

▲Pn132=0:

只有零速度状态下, 切换信号发生改变, 模式切换才有效; 如果不在零速度状态下, 切换信号发生了改变, 随后信号进入零速度状态, 则不发生模式切换。Only the zero velocity condition, switching signal changes, the mode switch is valid; If not zero velocity state, the switching signal is changed, then enter into the state of zero speed signal, the mode switch does not occur.

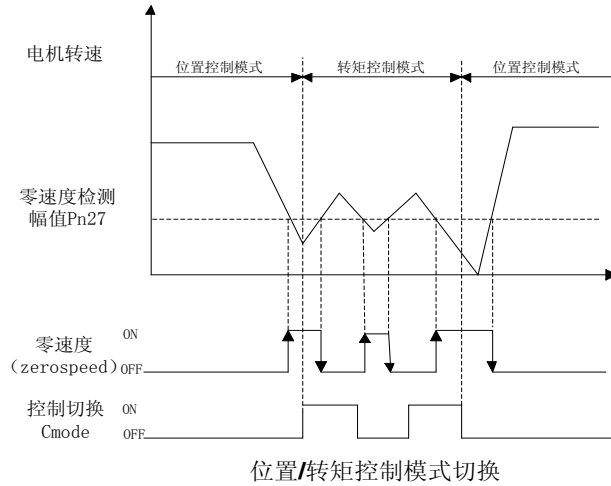

▲Pn132=1:

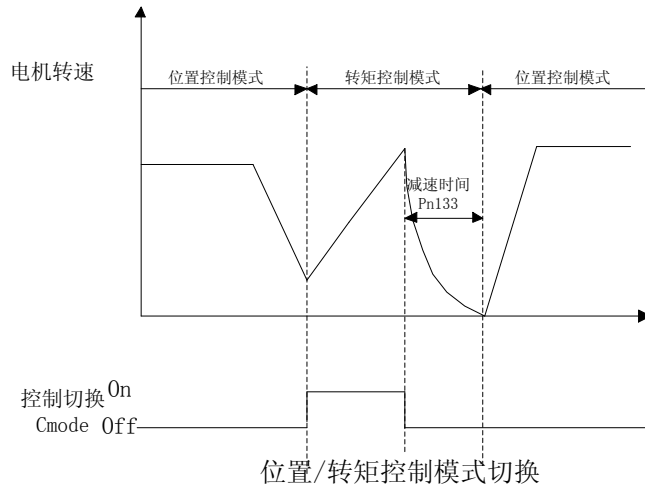

B.3 速度/转矩控制模式切换 Speed/torque control mode switch

使用控制切换(cmode), 可通过输入控制端口SigIn接点进行速度控制模式和转矩控制模式的切换。
Using the control switch (cmode), can be controlled by input port SigIn contact for speed control mode and the torque control mode switching.

cmode和控制模式的关系如下所示。Cmode relationship with control mode is shown below.

Cmode	控制模式control mode
OFF	速度控制模式position control mode
ON	转矩控制模式Torque control mode

不管何时都可以进行控制模式的切换，切换的时序图如下所示：Whenever can control mode switch, switching sequence diagram as shown below:

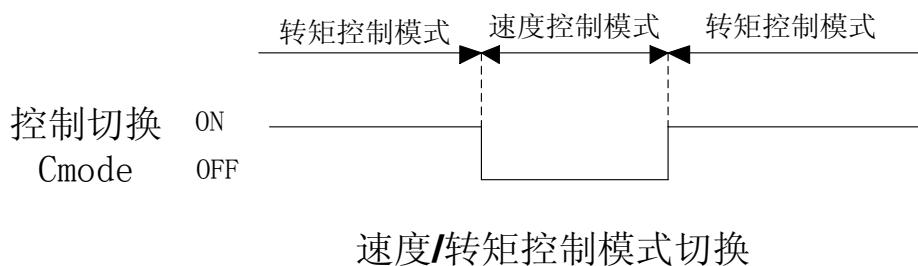

附录 C 伺服驱动器工作时序 Appendix C servo driver work sequence

C.1 电机静止时的 ON/OFF 动作时序 Motor resting ON/OFF action sequence

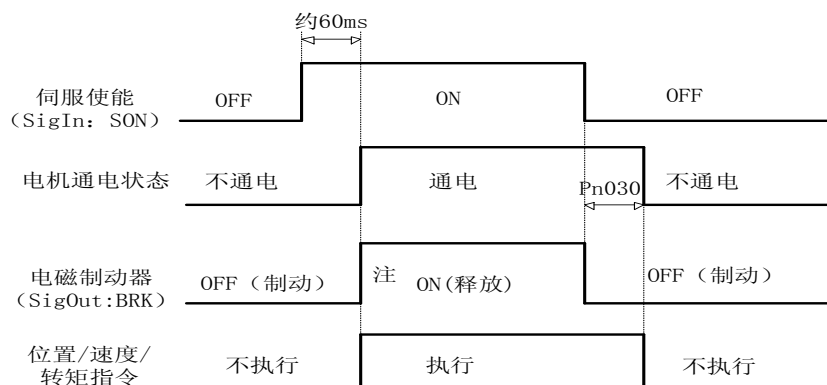

注 1: 使用电磁制动功能时, 伺服断使能方式 Pn004 必须设置为 2。Note 1: when using electromagnetic brake function, servo broken way can make Pn004 must be set to 2.

注 2: 当电机转速低于参数 Pn029 时, 电磁制动器的动作时序。Note 2: when Pn029 motor speed is lower than the argument, the electromagnetic brake action sequence.

C.2 电机运转时的 ON/OFF 动作时序 In the operation of the motor ON/OFF action sequence

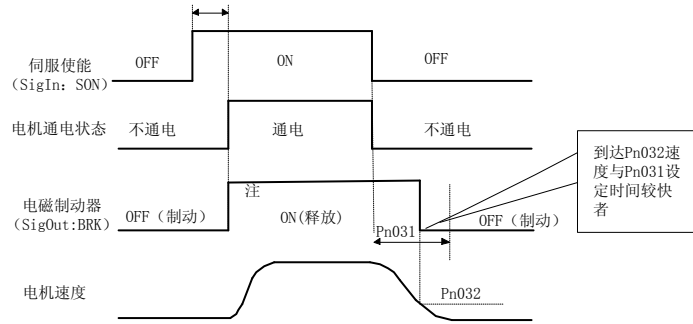

注 1: 使用电磁制动功能时, 伺服断使能方式 Pn004 必须设置为 2 Note 1: when using electromagnetic brake function, servo broken way can make Pn004 must be set to 2

注 2: 当电机转速不低于参数 Pn029 设定值时, 电磁制动器的动作时序。 Note 2: when the motor speed is not lower than Pn029 setting parameters, the electromagnetic brake action sequence.

C.3 伺服 ON 时报警的时序 When the servo ON alarm sequence

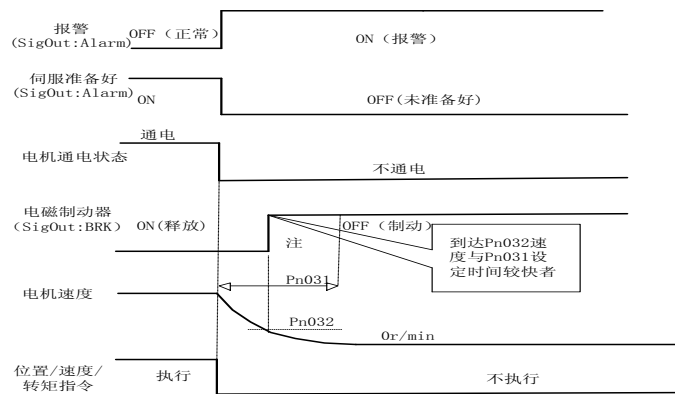

注 1: 使用电磁制动功能时, 伺服断使能方式 Pn005 必须设置为 2 Note 1: when using electromagnetic brake function, servo broken way can make Pn005 must be set to 2

附录 D 电磁制动器 Appendix D electromagnetic brake

电磁制动器（保持制动器、失电制动器），用于锁住与电机相连的垂直或倾斜工作台，防止伺服电源失去后工作台跌落。实现这个功能，须选购带制动器的电机。制动器只能用来保持工作台，绝不能用于减速和停止机器运动。 Electromagnetic brake (to keep the brakes, brake losing electricity, are connected to the motor is used to lock the vertical or inclined workbench, prevent the servo power after losing the workbench. Implement this function, you must choose and buy motor with brake. The brake can be used to keep the workbench, must not be used to slow down and stop the machine movement.

使用电磁制动器，必须设置 Pn004 参数为 2,并在 SigOut 端口指定功能。驱动器根据电机运行的转速，依照参数 Pn029 设定值，选择相应的制动时序，执行电磁制动功能。具体时序详见附录 C。Pn004 parameter must be set using the electromagnetic brake, to 2, and specify the SigOut port function. Pn029 drive according to the speed of the motor running, according to the parameters setting, choose corresponding braking time sequence, perform the function of electromagnetic brake. Please refer to the appendix C for specific timing.

附录 E 再生制动电阻 Appendix E regenerative braking resistor

当伺服电机运转在发电机模式时，电能会由电机流向驱动器，称为再生电力。以下使用情况，会使伺服电机运转在发电机(再生)模式：When servo motor running in generator mode, electricity will flow by motor drives, called renewable electricity. The following usage, can make the servo motor running in generator (renewable) mode:

- (1) 伺服电机在加减速运转时，由减速到停止期间。Servo motor, the deceleration is running by slowing down to stop.
- (2) 应用于垂直负载时。When applied to the vertical load.
- (3) 由负载端驱动伺服电机运转时。Driven by load operation of the servo motor.

此再生电力会由驱动器的主回路滤波电容吸收，但是再生电力过多时，滤波电容无法承受时，必须使用再生电阻来消耗多余的再生电能。当出现再生能量过大，内部制动电阻不能完全吸收，导致出现 AL-03(过压)、AL-08（过温）或 AL-16(制动平均功率过载)等报警。根据实际应用，增加加减速时间，若仍旧报警，就需要外接制动电阻，增强制动效果。外接制动电阻阻值范围 40~200 欧姆，功率 1000~50W，阻值越小，制动电流越大，所需制动电阻功率越大，制动能量越大，但阻值太小会可能造成损坏驱动器，试验方法是阻值由大到小，直到驱动器不再出现报警，同时运行时，制动电阻温度不太高即可。外接制动电阻时，拆去内部再生制动电阻。由于再生电阻在消耗再生电力时，会产生 100°C 以上高温，请务必小心，在连接再生电阻的电线请使用耐热不易燃的线材，并确认再生电阻没有碰触任何物品。The renewable electricity will be absorbed by the drive of the primary loop filter capacitor, but too much renewable electricity, filter capacitance cannot afford, regenerative resistor must be used to burn off excess renewable electricity. When there is a renewable energy is too large, the internal brake resistance cannot be fully absorbed, resulting in AL - 03 (overvoltage), AL - 08 (temperature) or AL - 16 (such as brake average power overload) call the police. According to the practical application, increase deceleration time, if still alarm, requires external braking resistance, enhance the braking effect. External braking resistance tolerance range of 40 ~ 200 ohms, 1000-50 w, the smaller the value, the braking current, the greater the power, the greater the braking resistance is required for braking energy is larger, but the value is too small may cause damage to the drive, resistance test method is from big to small, until the alarm is no longer present drives, running at the same time, the brake resistance temperature is not too high. When external braking resistor, down the internal regenerative braking resistor. Because regenerative resistor in the

consumption of renewable power, can produce high temperature above 100 ° C, please be careful, the connection of regenerative resistor wire please use of heat-resistant non-flammable cables, and confirm the regenerative resistor without touching anything.

注意：使用再生电阻时如果有上述报警产生，请切断电源，冷却半小时。由于再生晶体管发生故障，再生电阻异常发热，可能会造成火灾。请务必根据应用场合，选择相匹配的制动电阻。Note: if the alarm when using regenerative resistor, please cut off power supply, cooling and a half hours. Due to the regenerative transistor failure, abnormal regeneration resistance heating, may cause a fire. Please be sure to choose according to applications, matching the braking resistor.

附录 F 原点回归 Appendix F origin point

F.1 原点回归运行步骤 F.1 origin point operation steps

1: 找参考点 Looking for a reference point

启动原点回归功能后，按原点加归第一速度寻找参考点，可使用 SigIn 输入端子 REF、CCWL 或 CWL 作为参考点，也可以 Z 脉冲作为参考点，可选择正转或反转方向寻找。After start origin regression function, looking for reference point at the origin and return to the first rate, can use SigIn input terminals REF, CCWL or cwl as a reference point, can also be Z pulse as a reference point, can choose forward or reverse direction finding.

2: 找原点 find the origin

当找到参考点后，再以第二速度寻找原点，可选择继续向前或向后折返找 Z 脉冲，也可以直接以参考点作原点。When find reference point, and then to find the origin at the second speed, can choose continue to forward or backward turn-back find Z pulse, may also directly to the reference point for the origin.

原点回归执行过程中，为避免速度剧烈变化造成的机械冲击，可设置参数 Pn040、Pn041 进行加减速。找到的原点加上偏移量脉冲作为实际原点，偏移量为：

$Pn036 * 10000 + Pn037$ 。

Origin point execution process, to avoid rapid changes of mechanical impact velocity, can be set parameters for deceleration Pn040, Pn041. Find the origin and offset pulse as actual origin, the offset is:

$Pn036 * 10000 + Pn037$ 。

原点回归参考点模式(Pn034)和原点模式(Pn035)有以下组合：The origin return reference point mode (Pn034) and the origin (Pn035) has the following combination:

Pn034 \ Pn035	0	1	2	3	4	5
0	✓(A)	✓(B)	✓(A)	✓(B)	X	X
1	✓(C)	✓(D)	X	X	X	X
2	✓(E)	✓(F)	X	X	✓(G)	✓(H)

其中✓表示原点模式组合会正常执行，X表示原点模式组合不会执行。

F.2 原点回归触发时序 The origin return to trigger sequence

Pn033	原点回归触发方式 The origin is triggered	<p>0:关闭原点回归功能 Close the origin regression function</p> <p>1: 由 SigIn 输入的 GOH 电平触发 Triggered by the GOH SigIn input level</p> <p>2: 由 SigIn 输入的 GOH 边沿触发 GOH edge triggered by SigIn input</p> <p>3: 上电自动执行一次 Electricity automatically perform again</p>
-------	----------------------------------	--

电平触发 (Pn033=1) Level trigger (Pn033 = 1)

伺服使能后，输入端子 GOH 触发原点回归执行，GOH 上边沿开始回归操作，暂停正常指令执行，下边沿结束回归操作。GOH 一直保持 ON,回归执行完后，位置偏差清零(位置控制)，输出端子 HOME 变为 ON。直到 GOH 变为 OFF,则 HOME 变为 OFF。Servo enabled, the input terminals GOH triggered the origin return to execute, GOH edge began to return to operation, the suspension of normal instruction execution, the end of the edge back to operation. GOH has kept ON, after the return to perform, position deviation reset (position control), the output terminal HOME ON. Until GOH is OFF, is HOME to OFF.

当 Pn044=0 时，原点回归完成后等待 HOME 信号 变为 OFF 后再 执行指令，等待期间电机停留在原点，不接受指令；当 Pn044=1 时，原点回归完成后立刻执指令。When Pn044 = 0, origin wait for after the completion of the HOME after the signal into a OFF again executes instructions, waiting for the motor during stay at the origin, not accept instructions; When Pn044 = 1, the origin return immediately after the completion of the instructions.

在原点回归执行中，如果取消伺服使能 SON、产生任何报警、GOH 提前变为 OFF，则原点回归功能中止且输出端子 HOME 不动作。此外，如果使能 son 有效、没有报警，回归在执行中且没有完成，即使边沿触发 (Pn033=2) 信号重复有效，则驱动器会完成当前回归操作后，再检测边沿触发信号。At the origin in the execution of regression, if cancel the servo can make SON, produce any alarm, GOH into OFF ahead of schedule, the origin of regression function suspension and output terminals HOME not action. In addition, if effective, no alarm, can make the son return in execution and there is no complete, even if the edge triggered (Pn033 = 2) repeat signals effectively, the drive will be completed the current return after operation, to detect edge trigger signal.

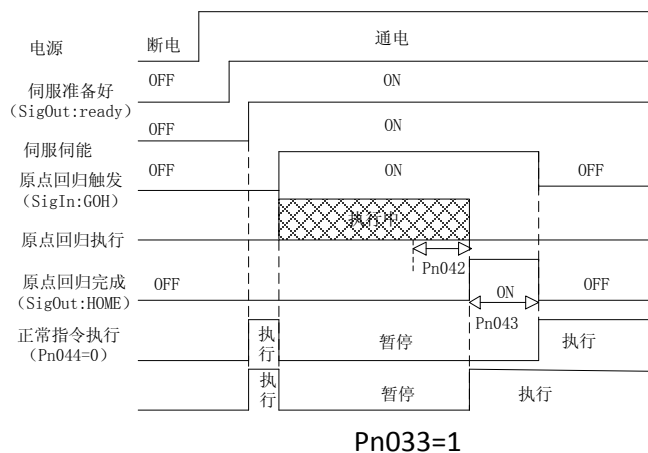

边沿触发 (Pn033=2) Edge triggered (Pn033 = 2)

伺服使能后，输入端子 GOH 上升触发原点回归执行，并暂停正常指令执行 Servo enabled, the input terminals GOH rise triggered the origin return to perform, and suspension of normal instruction execution

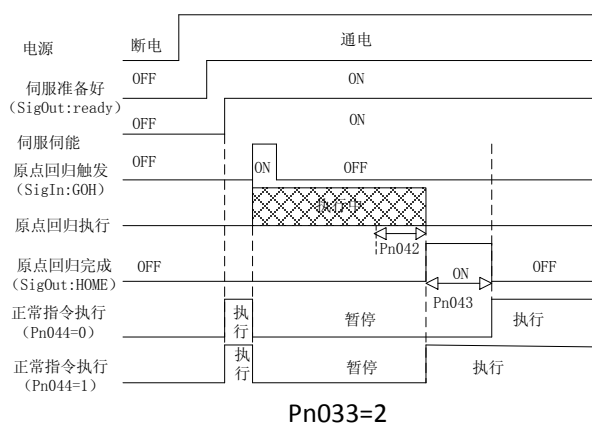

上电自动执行 (Pn033=3) Electricity automatically perform (Pn033 = 3)

此功能仅于上电后伺服初次使能有效时执行一次，以后不需要重复运行原点回归的情况。每次上电，驱动器自动执行一次原点回归操作。使用此功能可以节省一个输入端子 GOH。 This function only in electric servo make effective for the first time after the execution time, later don't need to repeat the origin regression. Every time it with electricity, drive automatically perform an origin point operations. Use this feature can save one input terminal GOH.

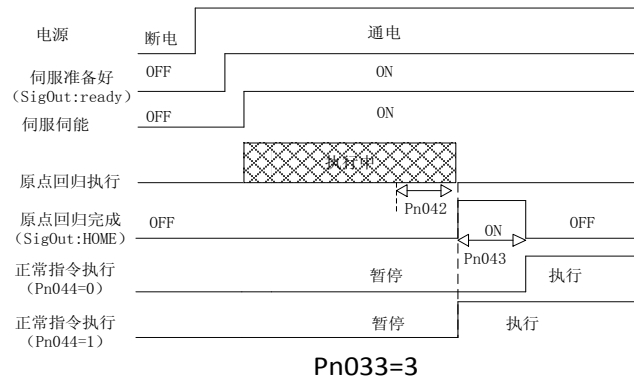

F.3 原点回归组合模式时序 The origin model time-series regression combination

Pn034	原点回归参考点模式 The origin return reference point model	<p>0:正转找 REF(上升沿触发)作参考点 Forward looking for REF (rising along the trigger) as a reference point</p> <p>1:反转找 REF(上升沿触发)作参考点 Inversion for REF (rising along the trigger) as a reference point</p> <p>2:正转找 CCWL(下降沿触发)作参考点 Forward looking for CCWL falling edge (trigger) as a reference point</p> <p>3:反转找 CWL(下降沿触发)作参考点 Inversion to find.cwl falling edge (trigger) for reference</p> <p>4:正转找 Z 脉冲作参考点 Forward looking for Z pulse as a reference point</p> <p>5:反转找 Z 脉冲作参考点 Pulse inversion for Z as a reference point</p>	0~5	0
Pn035	原点回归原点模式 The origin back to the origin model	<p>0: 向后找 Z 脉冲作原点 Backward looking for Z pulse as the origin</p> <p>1: 向前找 Z 脉冲作原点 Forward looking for Z pulse as the origin</p> <p>2: 直接以参考点上升沿作原点 Directly with reference point rise along the origin</p>	0~2	0

注 1: 通过组合参数 Pn034 和 Pn035, 有 8 种可用的原点回归方式。Note 1: by combining Pn034 and Pn035 parameters, there are eight kinds of available ways of origin.

注 2: 在原点回归操作时, 将关闭正/反驱动禁止功能, 直至退出回归操作。Note 2: when operating at the origin regression will close/reverse driving ban function, until the exit to return to operation.

(A)Pn034=0 或 2,Pn035=0

参数 parameter	设定 set	说明 instruction
Pn034	0 或 2 0 or 2	原点回归启动后, 按回归第一速度正转找 REF(上升沿触发)或 CCWL(下降沿触发)作参考点 Origin starts, to return to the first speed forward looking for REF (rising along the trigger) or CCWL falling edge (trigger) as a reference point
Pn035	0	到达参考点后, 按回归第二速度向后找 Z 脉冲作原点 Arriving at reference points, the backward looking for Z pulse to return to the second speed as the origin

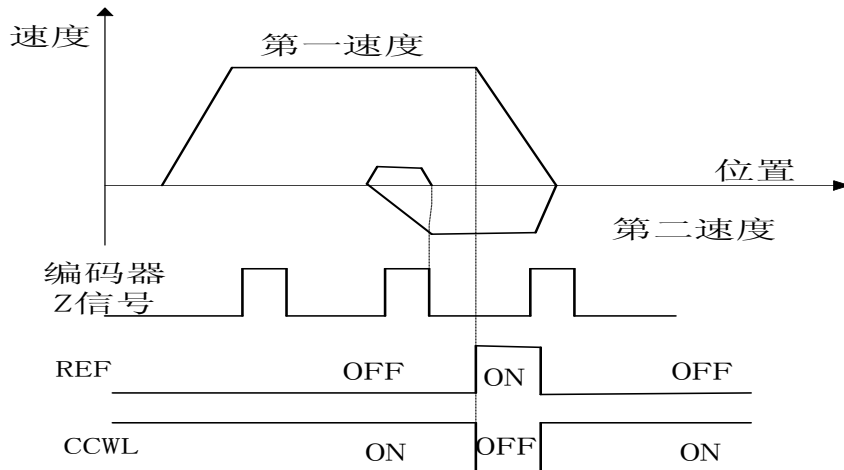

(B)Pn034=1 或 3,Pn035=0

参数 parameter	设定 set	说明 instruction
Pn034	1 或 3	原点回归启动后, 按回归第一速度反转找 REF (上升沿触发) 或 CWL(下降沿触发)作参考点 Origin starts, to return to the first speed inversion for REF (rising along the trigger) or.cwl falling edge (trigger) as a reference point
Pn035	0	到达参考点后, 按回归第二速度向后找 Z 脉冲作原点 Arriving at reference points, the backward looking for Z pulse to return to the second speed as the origin

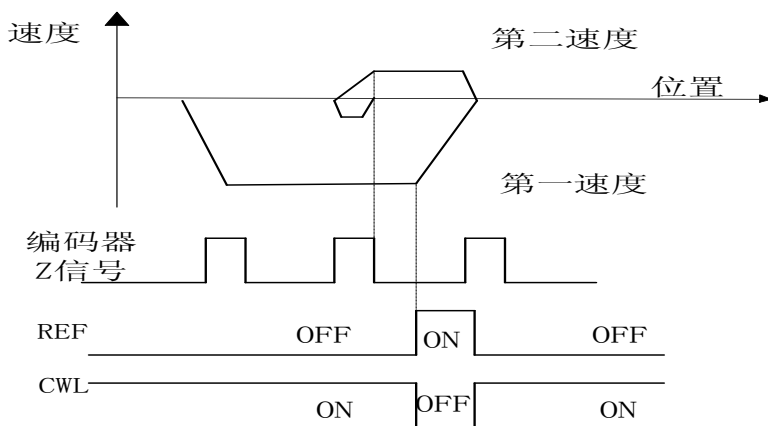

(C) Pn034=0, Pn035=1

参数 parameter	设定 set	说明 instruction
Pn034	0	原点回归启动后，按回归第一速度正转找 REF(上升沿触发)作参考点 Origin starts, to return to the first speed forward looking for REF (rising along the trigger) as a reference point
Pn035	1	到达参考点后，按回归第二速度向前找 Z 脉冲作原点 Arrived at the reference point, to return to the second speed forward looking for Z pulse as the origin

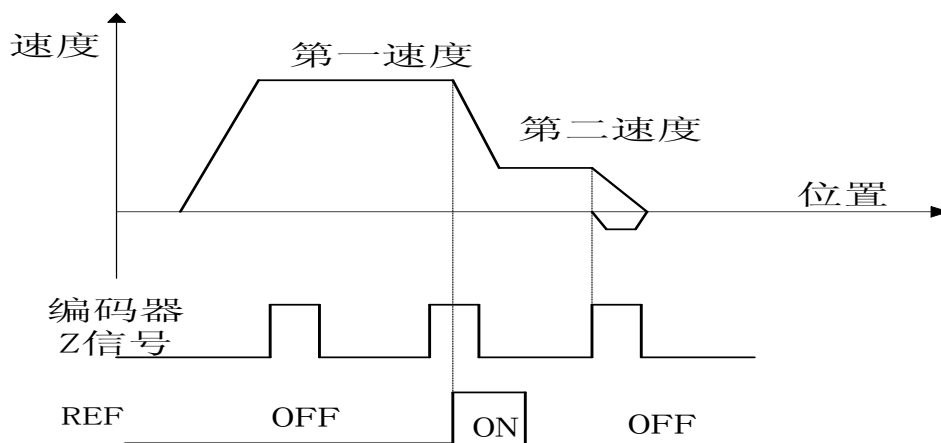

(D) Pn034=1, Pn035=1

参数 parameter	设定 set	说明 instruction
Pn034	1	原点回归启动后，按回归第一速度反转找 REF(上升沿触发)作参考点 Origin starts, to return to the first speed inversion to find the REF (rising

		along the trigger) as a reference point
Pn035	1	到达参考点后，按回归第二速度向前找 Z 脉冲作原点 Arrived at the reference point, to return to the second speed forward looking for Z pulse as the origin

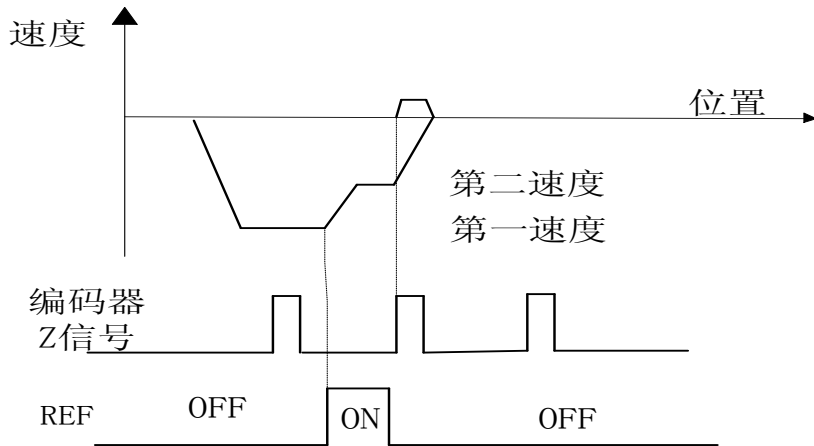

(E)Pn034=0,Pn035=2

参数 parameter	设定 set	说明 instruction
Pn034	0	原点回归启动后，按回归第一速度正转找 REF(上升沿触发)作参考点 Origin starts, to return to the first speed forward looking for REF (rising along the trigger) as a reference point
Pn035	2	到达参考点后，直接以参考点作为原点 Arriving at reference points, the direct reference point as the origin

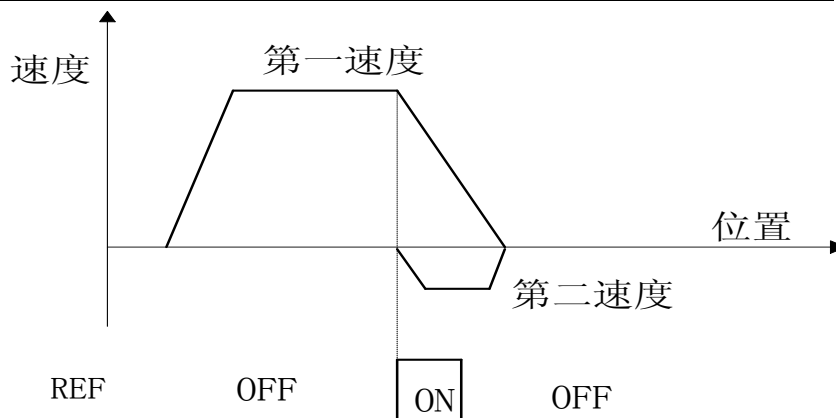

(F)Pn034=1,Pn035=2

参数 parameter	设定 set	说明 instruction
Pn034	1	原点回归启动后, 按回归第一速度反转找 REF(上升沿触发)作参考点 Origin starts, to return to the first speed inversion for REF (rising along the trigger) as a reference point
Pn035	2	到达参考点后, 直接以参考点作为原点 Arriving at reference points, the direct reference point as the origin

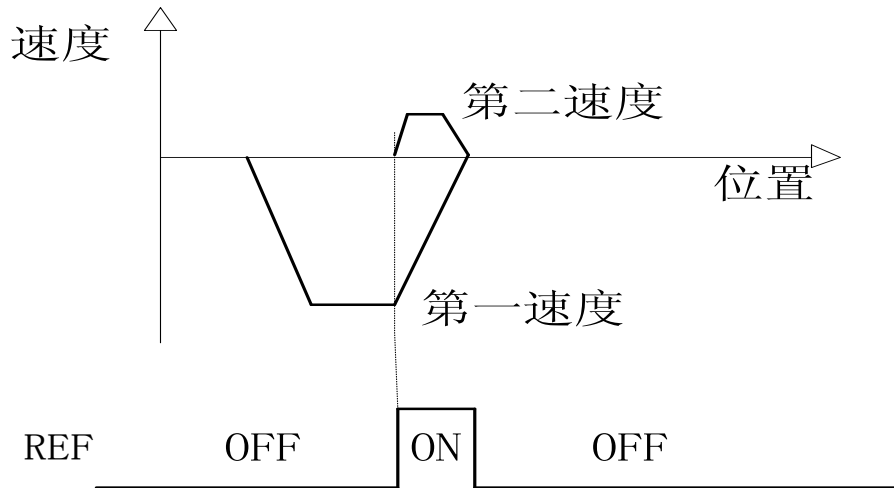

(G)Pn034=4,Pn035=2

参数 parameter	设定 set	说明 instruction
Pn034	4	原点回归启动后, 按回归第一速度正转找 Z 脉冲作参考点 Origin starts, to return to the first speed forward looking for Z pulse as a reference point
Pn035	2	到达参考点后, 直接以参考点作为原点 Arriving at reference points, the direct reference point as the origin

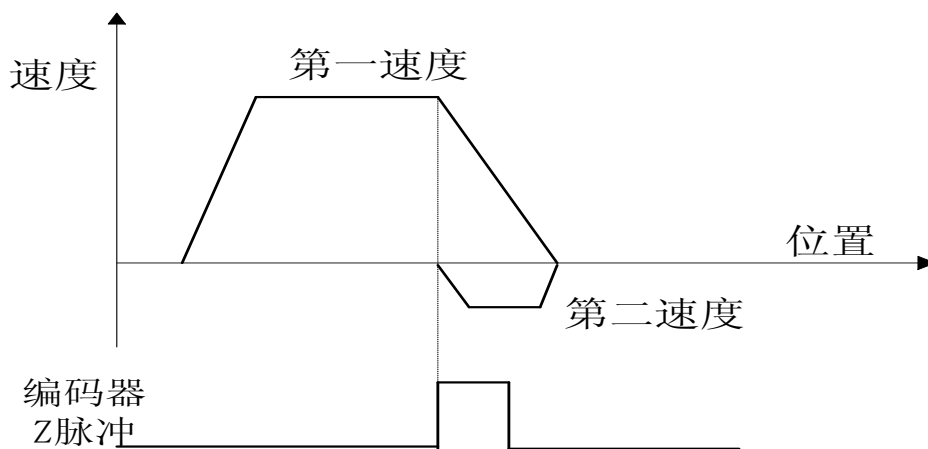

(H)Pn034=5,Pn035=2

参数 parameter	设定 set	说明 instruction
Pn034	5	原点回归启动后，按回归第一速度反转找 Z 脉冲作参考点 Origin starts, to return to the first speed pulse inversion for Z as a reference point
Pn035	2	到达参考点后，直接以参考点作为原点 Arriving at reference points, the direct reference point as the origin

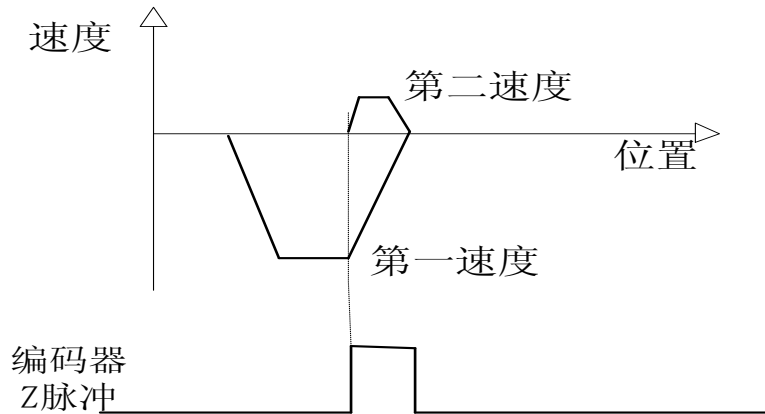

附录 G 内部位置控制 The appendix G internal position control

进行内部位置控制，需设置 Pn002=2, Pn117=1, 以及在 Pn118~Pn131 设置相应的运行参数。SigIn 端口的 pos1, pos2 选择内部位置指令 N: An internal position control, need to set Pn002 = 2, Pn117 = 1, and in Pn118 ~ Pn131 set up corresponding operation parameters. SigIn port pos1, pos2 choose internal position command N:

Pos2	Pos1	内部位置指令 N internal location instructions N
1	1	内部位置指令 0
1	0	内部位置指令 1
0	1	内部位置指令 2
0	0	内部位置指令 3

使用内部位置控制时，先确定输入端口 pos1, pos2 的状态，即选择相应的内部位置指令，然后触发输入信号 ptriger，每次 ptriger(OFF->ON)下降沿的时候，驱动器就读取内部位置指令 N，累加至剩余的指令脉冲数中，继续执行相应的操作。When using internal position control, make sure the input port pos1, pos2 state, namely choose corresponding internal position command, and then trigger ptriger input signal, each ptriger

(OFF -> ON) falling edge, the driver will read instruction N internal position, accumulate to the rest of the order the number of pulses, continue to perform the corresponding operation.

如果设置Pn118=0,在位置移动过程中想暂停电机运行,当触发输入端口pstop信号,电机减速停止,然后驱动器自动清除剩余位置指令,当输入端口ptriger再次触发时,驱动器会根据当前pos1,pos2的状态,执行相应的位置指令,请参考以下时序图: If set Pn118 = 0, want to suspend the motor running, in the process of position when the trigger input port pstop signal, motor speed to stop, and then drive automatically remove residual position instruction, when the input port ptriger fire again, the drive will be based on the current pos1, pos2 state, execute the position of the corresponding instructions, please refer to the following sequence diagram:

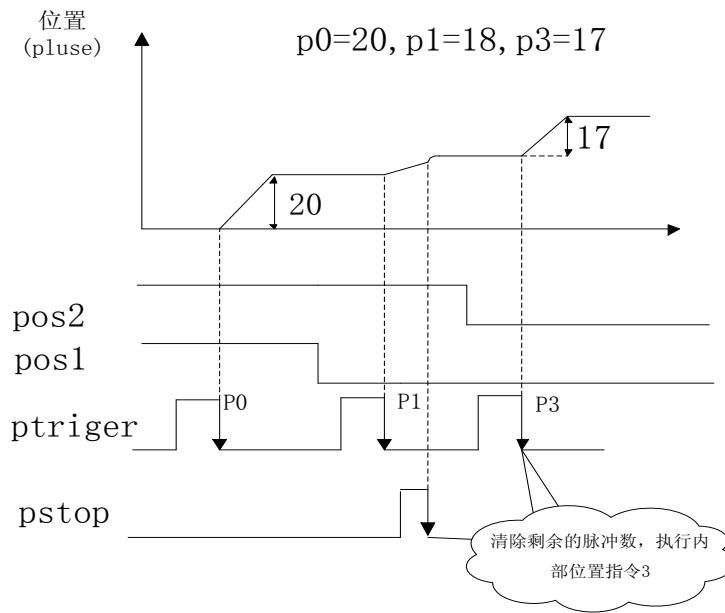

如果设置 Pn118=1,在位置移动过程中想暂停电机运转,当触发输入端口 pstop 信号,电机减速停止,当输入端口 ptriger 再次触发时,电机将继续走完剩余的位置指令,到达输入端口 pstop 触发前所下达的目标位置,请参考以下时序图: If set Pn118 = 1, want to pause in the process of the position the motor running, when the trigger input port pstop signal, motor speed to stop, when the input port ptriger fire again, the location of the electricity opportunities continue to walk the remaining instructions, the input port pstop trigger issued before the target location, please refer to the following sequence diagram:

